

RMMC 2-01

**Proper Wear and
Appearance of
Royal Marine Uniforms
RMMC 2-01**



***Bureau of
Communications***

Landing, Manticore



**THE ROYAL
MANTICORAN NAVY**

**The Official Honor Harrington
Fan Association**

THE ROYAL MANTICORAN NAVY

**Office of the Fourth Space Lord
Department of Uniform Manuals
RMMC 2-01**

Proper Wear and Appearance of Royal Marine Uniforms

REVISION ALPHA



**Bureau of Communications
Admiralty House
Landing, Manticore**

RMMC 2-01

RMMC 2-01 Proper Wear and Appearance of Royal Marine Uniforms

Published as RMMCR-0100 RMMC Uniform Regulations 19AUG2014

Revised as RMMC 4-2 Proper Wear and Appearance of Royal Marine Uniforms 01SEP2016

Revised as RMMC 2-01 Proper Wear and Appearance of Royal Marine Uniforms 25FEB2018

Revised as RMMC 2-01 Proper Wear and Appearance of Royal Marine Uniforms (Revision Alpha) 21MAR2018

The Royal Manticoran Navy
Bureau of Communications
Department of Uniform Manuals
Admiralty House
Landing, Manticore

Commodore Zachary White, KDE, MC, OG, MR, QBM, RMN
Director, Department of Uniform Manuals

Rear Admiral of the Red David Weiner, KSK, GCE, CGM, RMN
Fourth Space Lord
Baron Serpent Head Point

Formatted by: Lieutenant(SG) Karyn Hill, KE, and Commodore Zachary White

Edited by: Commodore Zachary White

Illustrations by: Senior Chief Warrant Officer Ryan Gale, CGM, RMN

Captain(JG) William Knight, KDE, MC, OG, CBM, RMN, Baron White Lion

Admiral of the Green Robert Bulkeley Jr, KSK, SC, DSO, CGM, RMN, Duke Mountain View

Commodore Zachary White

Special Thanks to the Uniform Board, and the Office of the Commandant for their assistance.

Chairman, Uniform Board: CSMCPO William Lochen, KSK, OC, KR, SC, NS, RMN, Baron LaMancha

RMMC Officer Liaison: General Sonja Wolf, OR, OG, ME, RMMC

RMMC Enlisted Liaison: Sergeant Major Greg Marchand, MC, SC, OG, NS, RMMC, Baron Tesseyman

Marshal of the Corps Sean Niemeyer, KSK, KDE, KCR, GS, RMMC

Commandant of the Royal Manticoran Marine Corps

Duke New Ulyanovsk

Special Notice: The programs, policies, requirements and regulations published in this manual are subject to continual review in order to serve the needs of The Royal Manticoran Navy: The Official Honor Harrington Fan Association members, and are subject to change at any time, as circumstances may require.

DISTRIBUTION RESTRICTION: Approved for public release; distribution is unlimited.

The Royal Manticoran Navy: The Official Honor Harrington Fan Association, Inc. Some rights reserved. Honor Harrington and all related materials © David Weber.

Table of Contents

Introduction	2
Convention Minimum	4
Orders of Dress for the RMMC	10
How to Use this Manual	11
Uniforms of the Royal Manticoran Marine Corps	13
Descriptions of Each Order of Dress	14
Cold Weather Fatigue Uniform.....	14
Working Uniform	19
Undress Uniform	24
Service Dress Uniform	29
Dress Uniform	34
Mess Dress Uniform	38
Special Uniforms of the Royal Manticoran Marine Corps	46
Special Uniforms - Fleet Marine Force Gunnery Sergeant.....	47
Special Uniforms - Regimental Sergeant Major	50
Special Uniforms - Sergeant Major of the RMMC.....	53
Measurement and Insignia Guide	56
Quartermaster's Corner	80

Introduction

Welcome

This manual has been designed for the member's ease of use. Please notice that the manual has been broken up into several sections: Uniforms of the Royal Manticoran Marine Corps, Special Uniforms of the Royal Manticoran Marine Corps, a Measurement and Insignia Guide, and the Quartermaster's Corner. Each of these sections can be easily found using the table of contents found on page 1.

This manual has also been designed so the user can quickly reference the description for an order of dress they desire, find their rank, and print the appropriate section. The same technique may be applied to the illustrations that follow, which also includes a required items entry listing the items required to build that particular uniform. Please note that all drawings are not to scale and should be considered for visual reference only. For accurate information on how to place buttons, where to place insignia, etc., please refer to the Measurement and Insignia Guide section of the manual as well as each illustration's accompanying textual description.

Note from the Author:

This manual is intended to act as a guide for those that wish to construct a canon uniform for the Royal Manticoran Marine Corps component within The Royal Manticoran Navy: The Official Honor Harrington Fan Association. While TRMN is a military fan association, the Uniform Board does recognize that not all members have the resources to construct a fully to spec uniform. The official policy of TRMN is, and will remain, one of "do your best," and we hope that members will utilize the resources available in this manual to accomplish that end.

Many options exist regarding uniforms, however the materials contained within should be considered best practices and are endorsed by the Uniform Board, Admiralty House and BuNine as keeping with the spirit and the brand of the Honorverse. For some items, however, there are no suitable substitutes, and in those rare cases, the exception has been noted. The information contained within these pages has been reviewed and passed by BuNine, Admiralty House, the head of the Royal Manticoran Marine Corps, and the Uniform Board, and should be considered the most up-to-date information available

This third edition brings with it a few changes and lessons learned from our first two go arounds. Please notice the updated artwork and illustrations, which now have the correct number of buttons and more accurate insignia, as well as some additional uniform options. The format has changed a little as well, both to make the manual a bit less bulky and easier to read, but to also bring this manual into compliance with the new style for uniform manuals unveiled with the release of the long awaited Grayson uniform manual late last year. I hope that you all like the new look and, as always, if there are any questions, comments, or additional corrections that are noticed please get in touch and we will make the necessary updates.

We love what we do, and we have made this manual as a labor of love to bring our vision of TRMN to you. We want you to look your best and have fun doing it! Thank you and enjoy!

From the Department of Uniform Manuals,
Commodore Zachary White



Introduction

Note from the Uniform Board:

“Congratulations Marine, you have been promoted!”

And with a handshake and a salute from your commanding officer you find yourself with a piece of embroidered cloth called a rank stripe, or perhaps a set of pins for your collar.

Now, you might say to yourself, “Wow! I want a uniform to start adding my rank to, only, I don’t know where to put my rank stripes, my regimental badge, my rank pins, or my name badge.”

Well, that is why this uniform manual was created. To help you succeed in creating your uniform so that it matches The Royal Manticoran Navy (TRMN) uniform regulations.

When many of us started to “uniform up,” we drew information from references within the books that came to be known as “canon,” chats with David Weber, or even from the cover art of the books. We needed guidance.

Happily, over the years, a group of folks have gathered information, drawings and measurements. They were presented to the TRMN leadership and then were sent to David Weber and his business group, BuNine, for approval. The information herein has been officially sanctioned by David Weber and BuNine for use by the official Honor Harrington Fan Association and are considered part of the organizations uniform regulations. That said, that doesn’t mean that a non-member that wants to cosplay cannot utilize this manual for those purposes. We hope that you will, and perhaps consider becoming a member in turn.

So dig in, and utilize this resource! Have fun making your uniform and attaching all those wonderful award ribbons, stripes, badges, and pins!

From the Director of the Uniform Board,

Command Senior Master Chief Petty Officer William Lochen



Convention Minimum

Official Dress Code for The Royal Manticoran Navy, The Official Honor Harrington Fan Association

Note from the Uniform Board and BuPlan – Please Read before Continuing:

While this manual details the various canon uniforms available to members of the Royal Manticoran Navy, they are by no means required in order for a member to represent the organization at a convention, chapter sponsored event, or to man one of the organization's fan tables.

That being said, the organization does have a minimum dress code that must be adhered to while representing the organization in any capacity. That adherence is necessary both to uphold the image of TRMN, The Official Honor Harrington Fan Association, as one of the premier science fiction fan organizations, but also to uphold the integrity of David Weber's intellectual property, a property that he has graciously allowed this organization to represent to the public in an official capacity.

We understand that sometimes putting together one of the canon uniforms that follow in this manual may be out of some member's immediate grasp, however we also believe that the principle of "do your best" applies not to throwing together any random ensemble and calling it a day, but rather in doing ones best to acquire the necessary items to construct a uniform that one can be proud to represent the organization in, and in the meantime, proudly representing the organization sharply in one of the many approved convention minimum options.

Wearing proper convention minimum is not just important because it makes you and your chapter look sharp, but it is also one of the organization's main recruiting tools. Like any large organization or corporation, TRMN has branding; an image that makes us instantly recognizable. A green beret paired with one of our approved logo shirts is akin to the Apple logo, or the Golden Arches or Mickey Mouse ears. TRMN has spent over a decade perfecting its brand image, and the mandate that our members wear proper convention minimum while representing the organization is part of that branding.

Some examples of convention minimum "DO's" and "DONT'S" have been included on the following pages.

The simplest, and probably the cheapest, way to sharply represent the organization is by purchasing a dark green polo shirt, or dark green tee-shirt, at your local WalMart or department store, and then adding the RMMC organizational logo patch, available from the Bureau of Supply, to the right or left breast. An example of this popular option is shown on page 5.

Please contact your chain of command, or the RMMC liaison to the Uniform Board with any questions.

For more information, and a complete listing of the available options, please reference Admiralty Order 1604-03 and Admiralty Order 1604-04.

Thank you for your cooperation and understanding! If we all work together we can contribute to another successful decade of one of the best science fiction fan organizations out there - The Royal Manticoran Navy, The Official Honor Harrington Fan Association.

Convention Minimum

Official Dress Code for The Royal Manticoran Navy, The Official Honor Harrington Fan Association

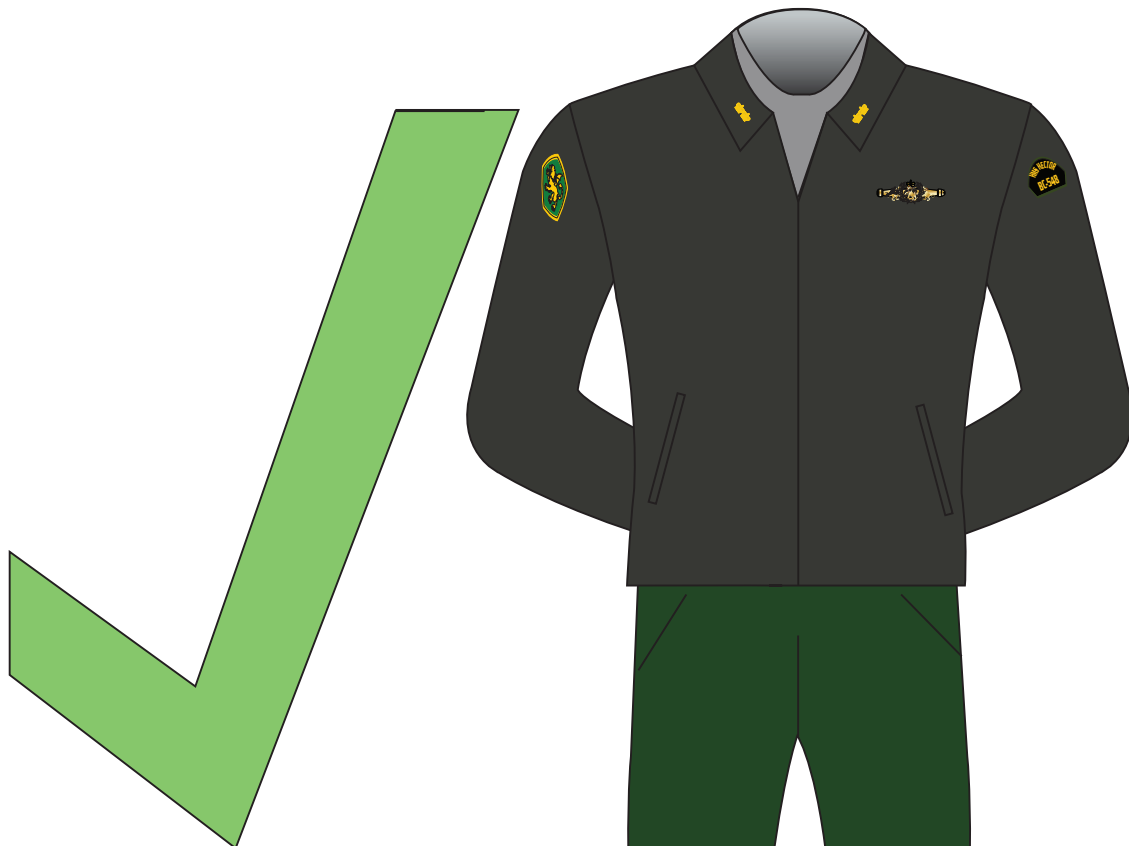
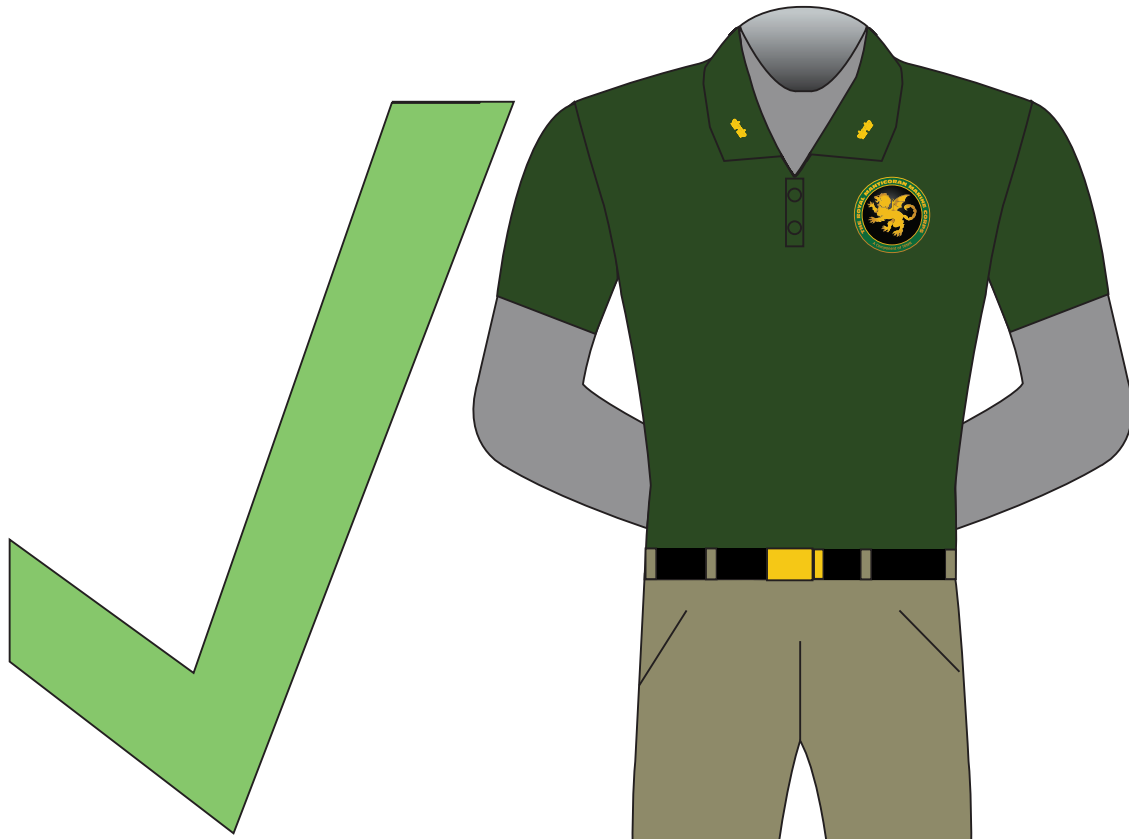

Convention Minimum

Official Dress Code for The Royal Manticoran Navy, The Official Honor Harrington Fan Association

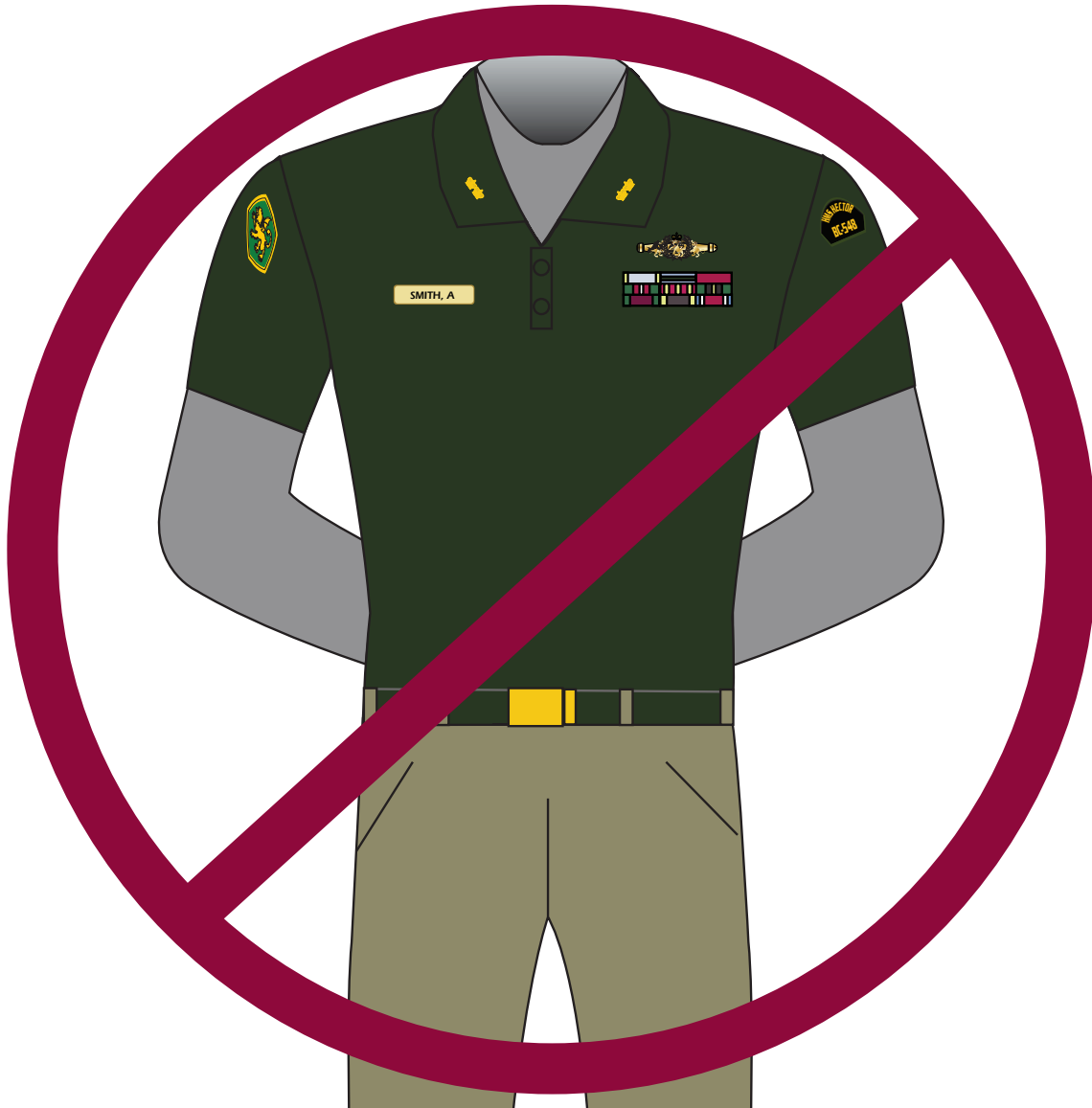

Convention Minimum

Official Dress Code for The Royal Manticoran Navy, The Official Honor Harrington Fan Association

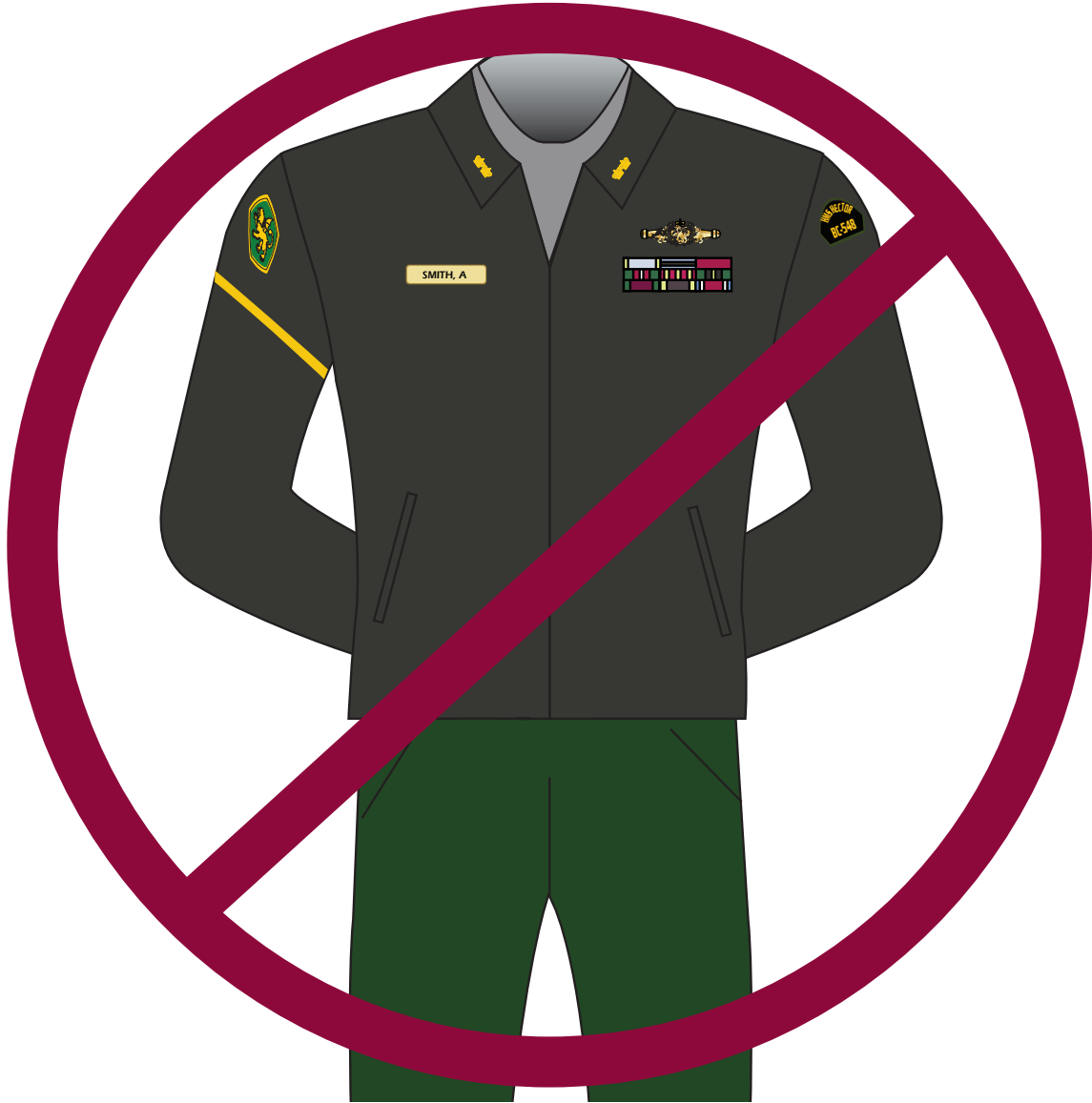

Convention Minimum

Official Dress Code for The Royal Manticoran Navy, The Official Honor Harrington Fan Association

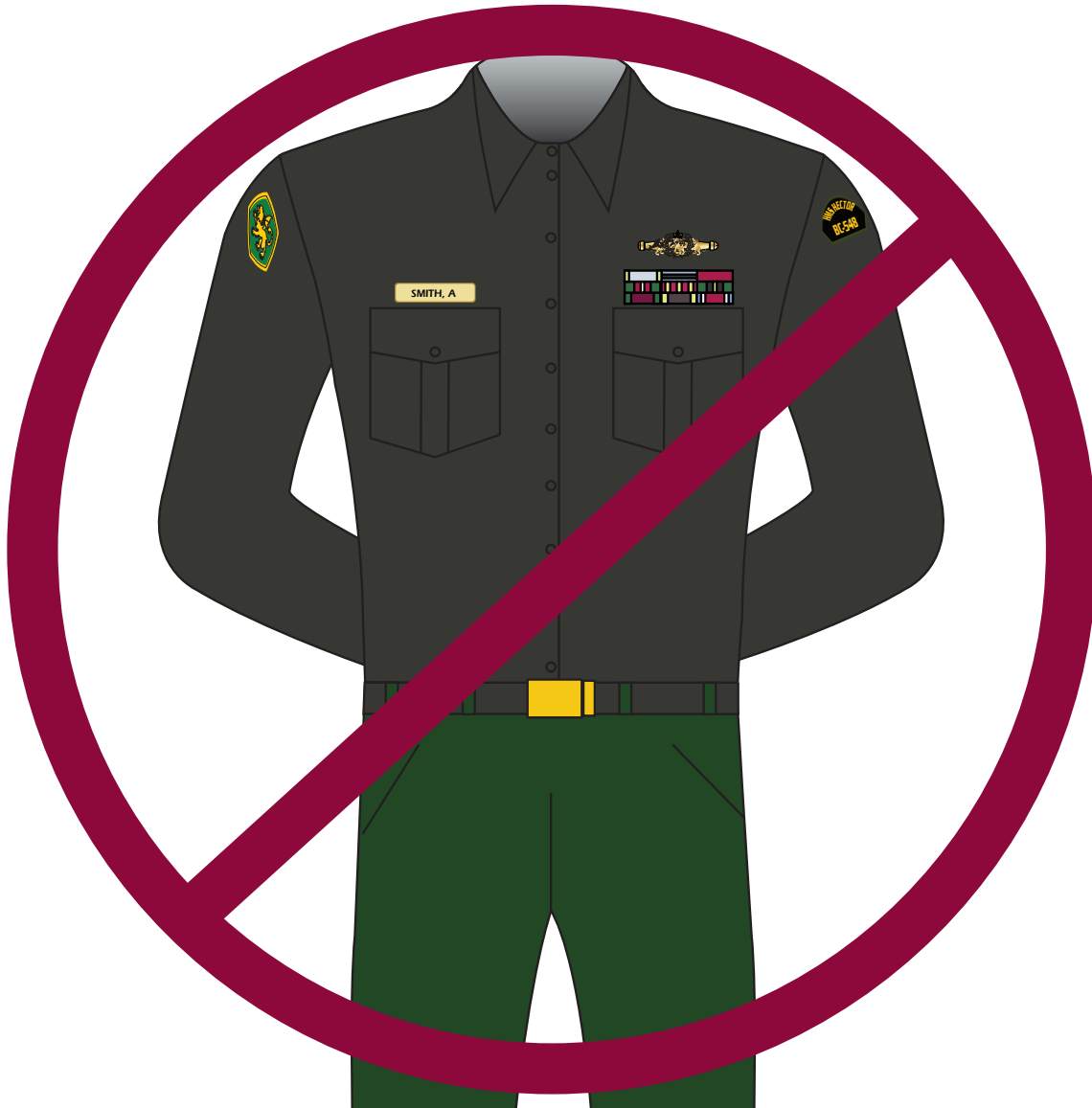



Orders of Dress for the RMMC

There are six orders of dress for personnel in the RMMC.

1. Cold Weather Fatigue Uniform
2. Working Uniform
3. Undress Uniform
4. Service Dress Uniform
5. Dress Uniform
6. Mess Dress Uniform (officers, warrant officers, and E-10 only)

Coveralls:

Coveralls are worn by all enlisted personnel for both the working and the undress uniform. Coveralls are worn by all officers and warrant officers for the working uniform only.

Uniform Tunic:

A tunic, paired with trousers, is worn by officers and warrant officers for all orders of dress following the working uniform. Enlisted personnel are authorized to wear two variations of the uniform tunic for specific uniforms. Senior non-commissioned officers in the grades of E-7 and above are authorized to wear the officer's uniform tunic for their dress uniform. All enlisted personnel wear a short, Eisenhower style, tunic for their service dress uniform.

The officer and warrant officer uniform tunic is pure black and the hem of the tunic should fall just below the wearers hips when the wearer is standing at military attention with their arms held at their sides. The tunic includes a plastron (bib) which is trimmed in quarter inch (1/4") forest green piping, excluding the bottom hem. The tunic features a mandrin style collar that should be close fitting, but not restrictively so, and two fabric epaulets, one on each shoulder. The collar is trimmed as per the tunic, the epaulets are untrimmed. It is suggested that two plastrons be purchased or constructed, one that is fitted with buttons, and one that does not have buttons. This strategy allows the wearer to effect each RMMC uniform variant, save the flag officer mess dress, with a single tunic. The flag officer mess dress tunic is a stylized frock coat type design and will be discussed further in this manual.

The enlisted short, Eisenhower style, tunic is pure black and should fall to the wearers waist when worn, covering any belt that is worn with the trousers. The tunic does not feature a plastron. The tunic zips up the front and features a zipper flap, closing to the right, that hides the zipper from view. The tunic features a mandrin style collar similar to that found on the officer tunic. The collar and the zipper flap are trimmed in 3/8" forest green grosgrain ribbon. There are no epaulets on the enlisted short jacket.

Quick Reference Table of Five Orders of Dress for the RMMC:

	Working Uniform	Undress Uniform	Service Dress Uniform	Dress Uniform	Mess Dress Uniform
OFFICERS	Coveralls	Tunic	Tunic	Tunic	Special
ENLISTED	Coveralls	Coveralls	Short Tunic	Officer's Tunic (E-7 through E-9 ONLY)	Special (E-10 ONLY)

As can be seen, enlisted personnel E-1 through E-6 do not have the option of wearing a dress uniform, as the service dress uniform is the most formal uniform variation afforded their rank. Enlisted personnel E-7 through E-9 do not have the option of wearing a mess dress uniform as the dress uniform is the most formal uniform variation afforded their rank.

How to Use this Manual

Uniform Type

General Description

Dress Uniform

The dress uniform is the most formal uniform many officers and warrant officers will wear during their time in the service, and the most formal uniform authorized for senior non-commissioned officers in the grades of E-7 through E-10. It is worn for formal duties, such as those involving interaction with the public. It is a more formal version of the service undress uniform. All personnel wear a uniform tunic for this uniform variant. The wearing of a sidearm or holster is not authorized with the dress uniform.

All ranks wear the RMMC patch affixed to the upper right sleeve.

All ranks wear their assignment patch and their regimental patch affixed to the upper left sleeve.

All ranks wear a forest green, close fitting, mock turtleneck.

All ranks wear a forest green RMMC beret with the RMMC flash positioned over the left eye.

All ranks may display awards that include a chest star, chest badge, or sash, if earned. Please consult TRMN-05, "Proper Wear and Display of the Knightly Orders and Chivalrous Awards," for further guidance.

All ranks wear forest green trousers, un-bloused, with shined black oxford uniform shoes or boots. A black uniform belt with a gold military friction buckle is worn. Personnel should not blouse the trouser legs with the dress uniform.

All ranks wear a gold, metal, name badge with black lettering, affixed with clutch pins or magnets, on the right breast of the uniform tunic. All name badges should feature the wearers last name, first initial. For an example of the name badge, as well as a guide to proper placement of insignia, buttons, and awards, please consult the Measurement and Insignia Guide section of this manual.

All ranks display medals on the left breast along with the Space Warfare Pin, if earned. If medals are unavailable, ribbons may be substituted. Any unit awards earned are displayed below the name badge.

Officers and warrant officers wear a uniform identical to that worn for the service undress with the following addition. A double row of 18 gold TRMN buttons are worn on the plastron, 9 buttons on each side. Additionally, all officers and warrant officers will wear a 7/8" black satin stripe down the outer seam of each leg, beginning at the waist and ending at the cuff.

Senior non-commissioned officers in the grades of E-7 through E-10 wear the same uniform tunic and trousers as officers and warrant officers, with the exception that they will wear a 1.5" black satin stripe down the outer seam of each leg, beginning at the waist and ending at the cuff.

Rank Specific Section

How to Use this Manual

Uniform Type

Rank Specific Section

Dress Uniform (continued)

Warrant Officers:

The RMMC patch is worn on the upper right sleeve.

The assignment patch and regimental patch are worn on the upper left sleeve

Rank insignia is worn on the collar and centered on the uniform tunic epaulets. RMMC brass is displayed on the uniform tunic epaulets. Warrant officers display silver rank chevrons appropriate to their rank on the left sleeve

Any award stripes earned are worn on the upper right sleeve, below the RMMC patch. For a guide to proper placement please consult the Measurement and insignia Guide section of this manual.

Required Items:

- | | |
|---|--|
| <ol style="list-style-type: none"> 1. Black uniform tunic with buttons 2. Forest green uniform trousers 3. 7/8" black satin stripe 4. Black uniform belt with gold military buckle 5. Black low-topped boots or shoes 6. Gold metal name badge 7. RMMC patch | <ol style="list-style-type: none"> 8. Award stripe(s) as earned 9. Assignment patch 10. Regimental patch 11. Gold/silver rank insignia 12. Silver rank chevron(s) 13. RMMC brass 14. Forest green compression mock turtleneck 15. Forest green beret with RMMC flash |
|---|--|



Items Needed to Make this Uniform

Uniform Illustration

Uniforms of the Royal Manticoran Marine Corps

The following section contains written descriptions and illustrations that cover all available RMMC uniforms. The written descriptions are broken down for officers, warrant officers, and enlisted personnel. The enlisted descriptions are further broken down to denote the differences between E-1 through E-3, and enlisted personnel in the grades of E-4 through E-9.

Each written description is designed to compliment the illustrations immediately following. Please reference the illustrations and the Measurement and Insignia Guide for proper placement of uniform items.

Important Note – Please Read before Continuing:

The artwork throughout this manual is for informational purpose only and included to provide a visual reference to supplement the text and the provided measurements. While every effort has been made to ensure the artwork is as accurate as possible, please default to the textual descriptions and the included measurements.

For the uniforms that include buttons, the dress and mess dress variants, the artwork will show unique “crossed rifles” gold buttons. While canonically correct, these buttons do not currently exist. Personnel should utilize the standard TRMN “crown” buttons for all uniforms that require them until such time as unique RMMC uniform buttons may become available.

For the small buttons on epaulets and the mess dress cuff detail, personnel should utilize plain gold, pocket sized, buttons from Marlow White, as the small “crossed rifle” RMMC buttons do not currently exist. Information on where to purchase all buttons may be found in the Quartermaster’s Corner section of the manual.

Thank you for your understanding.

PLEASE NOTE - ALL ARTWORK IN THIS MANUAL APPEARS WITH SLIGHTLY LIGHTENED GREEN UNIFORM ITEMS. THIS WAS DONE TO MAKE THE ARTWORK EASIER TO VIEW. THE CANON RMMC GREEN IS A DARK FOREST GREEN, AS WRITTEN IN EACH TEXTUAL DESCRIPTION AND AS NOTED IN EACH REQUIRED ITEMS LISTING.

Descriptions of Each Order of Dress

Cold Weather Fatigue Uniform

The cold weather fatigue uniform is worn for light duty in colder climates or outdoors while performing organizational duties that would otherwise require a canon uniform or convention minimum. This uniform may be worn by all ranks and may be considered on par with the working uniform and convention minimum.

All ranks will wear forest green uniform trousers or forest green BDU style pants. It is highly suggested, for the sake of a sharp, uniformed image, that members of each MARDET decide among themselves which trouser style to wear with the cold weather fatigue uniform and outfit themselves accordingly. All personnel wear a black uniform belt with a gold military friction buckle if wearing trousers. Those electing to wear BDU style pants may wear a plain black military "rigger" style belt.

OPTIONAL: A plain black, tactical style, belt may be worn with the RMMC pulser and its accompanying drop leg holster with both the uniform trousers and the BDU style pants

All ranks will wear a forest green, close fitting, mock turtleneck, and a black, "GI" or "Commando" style, military sweater. As with the uniform trousers, members of each MARDET should arrive at a consensus as to which type to purchase. Regardless of choice, the sweater must have epaulets and fabric reinforcement patches on the shoulders and elbows.

All ranks will wear an embroidered, flight suit style, name patch on the left breast. The patch is attached with Velcro and features the RMMC logo, the wearers name, rank, and assignment in gold lettering. The wearer may need to attach their own Velcro to accommodate this accessory if the sweater does not come with it attached. Several examples of this patch are provided in the Measurement and Insignia Guide section of the manual.

All ranks wear a forest green RMMC beret with the RMMC flash positioned over the left eye.

The RMMC patch, assignment patch, Space Warfare Pin, ribbon rack, award stripes, or any other articles not specifically indicated are not authorized for wear with the cold weather fatigue uniform.

Cold Weather Fatigue Uniform (continued)

Officers:

Officers wear their rank insignia centered on each epaulet.

RMMC shoulder brass is NOT worn.

Required Items:

1. Forest green uniform trousers or forest green BDU pants (shown)
2. Black uniform belt with gold military buckle or black "rigger" style belt
3. Black low topped boots
4. Forest green compression mock turtleneck
5. Black "GI" or "Commando" style military sweater
6. Forest green beret with RMMC flash
7. Black, flight suit style, name badge
8. Gold/silver rank insignia



Cold Weather Fatigue Uniform (continued)

Warrant Officers:

Warrant officers wear their rank insignia centered on each epaulet.

RMMC shoulder brass is NOT worn.

Required Items:

1. Forest green uniform trousers or forest green BDU pants (shown)
2. Black uniform belt with gold military buckle or black "rigger" style belt
3. Black low topped boots
4. Forest green compression mock turtleneck
5. Black "GI" or "Commando" style military sweater
6. Forest green beret with RMMC flash
7. Black, flight suit style, name badge
8. Gold/silver rank insignia



Cold Weather Fatigue Uniform (continued)

Enlisted:

Enlisted personnel in the grades of E-1 through E-3 display no insignia, save for the flight suit style name badge.

Required Items:

1. Forest green uniform trousers or forest green BDU pants (shown)
2. Black uniform belt with gold military buckle or black "rigger" style belt
3. Black low topped boots
4. Forest green compression mock turtleneck
5. Black "GI" or "Commando" style military sweater
6. Forest green beret with RMMC flash
7. Black, flight suit style, name badge



Cold Weather Fatigue Uniform (continued)

Enlisted:

Enlisted personnel in the grades of E-4 through E-10 display no insignia, save for the flight suit style name badge.

Additionally, enlisted personnel in the grades of E-4 through E-10 display a 1.5" black stripe down the outer seam of each leg, beginning at the waist and ending at the cuff, to denote their status as a NCO (pictured).

Required Items:

1. Forest green uniform trousers or forest green BDU pants (shown)
2. Black 1.5" grosgrain ribbon (E-4 through E-10 only)
3. Black uniform belt with gold military buckle or black "rigger" style belt
4. Black low topped boots
5. Forest green compression mock turtleneck
6. Black "GI" or "Commando" style military sweater
7. Forest green beret with RMMC flash
8. Black, flight suit style, name badge



Working Uniform

The working uniform is worn for duties that involve environments and tasks in which the wearer expects to get their clothing dirty. This uniform is also the first that many members will achieve and should be considered on par with the cold weather fatigue uniform and convention minimum.

All ranks wear black, one piece, coveralls with a mandrin style collar. No belt is worn. The coveralls are worn bloused into black, low-topped, boots.

All ranks wear a forest green, close fitting, mock turtleneck.

All ranks wear a forest green RMMC beret with the RMMC flash positioned over the left eye.

OPTIONAL: A plain black, tactical style, belt may be worn, with the RMMC pulser and its accompanying drop leg holster, with the working uniform. The belt should be worn over their coveralls, at the natural waist.

Unless otherwise specified, the RMMC patch, assignment patch, Space Warfare Pin, ribbon rack, award stripes, or any other article not specifically indicated, are not authorized for wear with the working uniform.

Working Uniform (continued)

Officers:

Officers wear a black fabric name tape with gold embroidered lettering affixed to their left breast. All name tapes should feature the wearers last name, first initial. For an example of the name tape, as well as a guide to proper placement, please consult the Measurement and Insignia Guide section of this manual.

Rank insignia is similarly embroidered in gold or silver thread on a black fabric tape and worn directly beneath the name tape so that the tapes are touching at their edge. Officers may also elect to wear their metal rank insignia, and it is displayed 1/4" below, and centered on, the name tape.

The RMMC patch is affixed to the upper right sleeve, and the assignment patch and regimental insignia is affixed to the upper left sleeve.

Required Items:

1. Black coveralls
2. Black low-topped boots
3. Black embroidered name tape
4. Black embroidered rank tape
5. RMMC patch
6. Assignment patch
7. Regimental patch
8. Forest green compression mock turtleneck
9. Forest green beret with RMMC flash

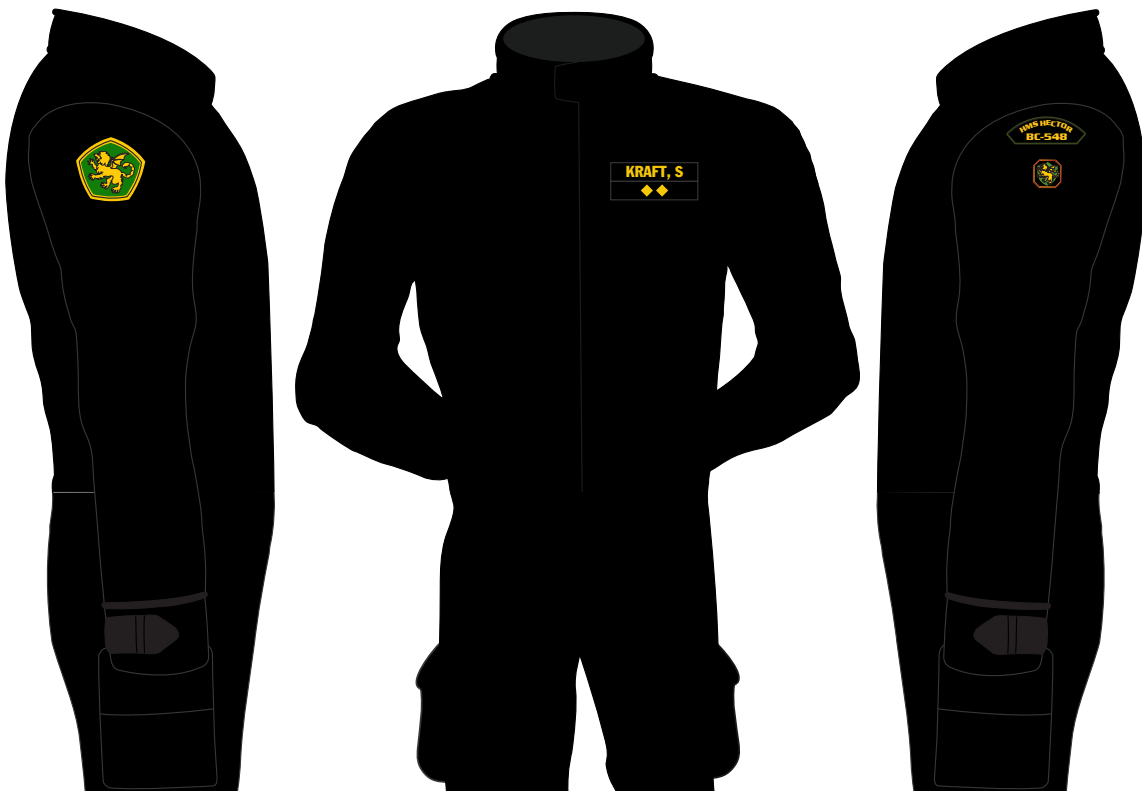

Working Uniform (continued)

Warrant Officers:

Warrant officers wear a black fabric name tape with gold embroidered lettering affixed to their left breast. All name tapes should feature the wearers last name, first initial. For an example of the name tape, as well as a guide to proper placement, please consult the Measurement and Insignia Guide section of this manual.

Rank insignia is similarly embroidered in gold or silver thread on a black fabric tape and worn directly beneath the name tape so that the tapes are touching at their edge. Warrant officers may also elect to wear their metal rank insignia, and it is displayed 1/4" below, and centered on, the name tape. Warrant officers will display the appropriate number of silver chevrons for their current rank on the left sleeve only

The RMMC patch is affixed to the upper right sleeve, and the assignment patch and regimental insignia is affixed to the upper left sleeve.

Required Items:

1. Black coveralls
2. Black low-topped boots
3. Black embroidered name tape
4. Black embroidered rank tape
5. RMMC patch
6. Assignment patch
7. Regimental patch
8. Silver rank chevrons
9. Forest green compression mock turtleneck
10. Forest green beret with RMMC flash



Working Uniform (continued)

Enlisted (E-1 through E-3):

Enlisted personnel in the grades of E-1 through E-3 wear a yellow fabric name tape with black embroidered lettering affixed to their left breast. All name tapes should feature the wearers last name, first initial. For an example of the name tape, as well as a guide to proper placement, please consult the Measurement and Insignia Guide section of this manual.

Enlisted personnel do NOT display an additional embroidered rank tape below their name tape.

Enlisted personnel will display the appropriate number of gold rank stripes for their current rank as well as their regimental insignia on the left sleeve only. Green service stripes, if earned, will be displayed on the lower left sleeve. For proper placement please consult the Measurement and Insignia Guide section of this manual.

The assignment patch and RMMC patch are not authorized for enlisted personnel wearing the working uniform, nor is any further ornamentation

Required Items:

1. Black coveralls
2. Black low-topped boots
3. Yellow embroidered name tape
4. Regimental patch
5. Gold rank stripes
6. Green service stripe(s) as earned
7. Forest green compression mock turtleneck
8. Forest green beret with RMMC flash

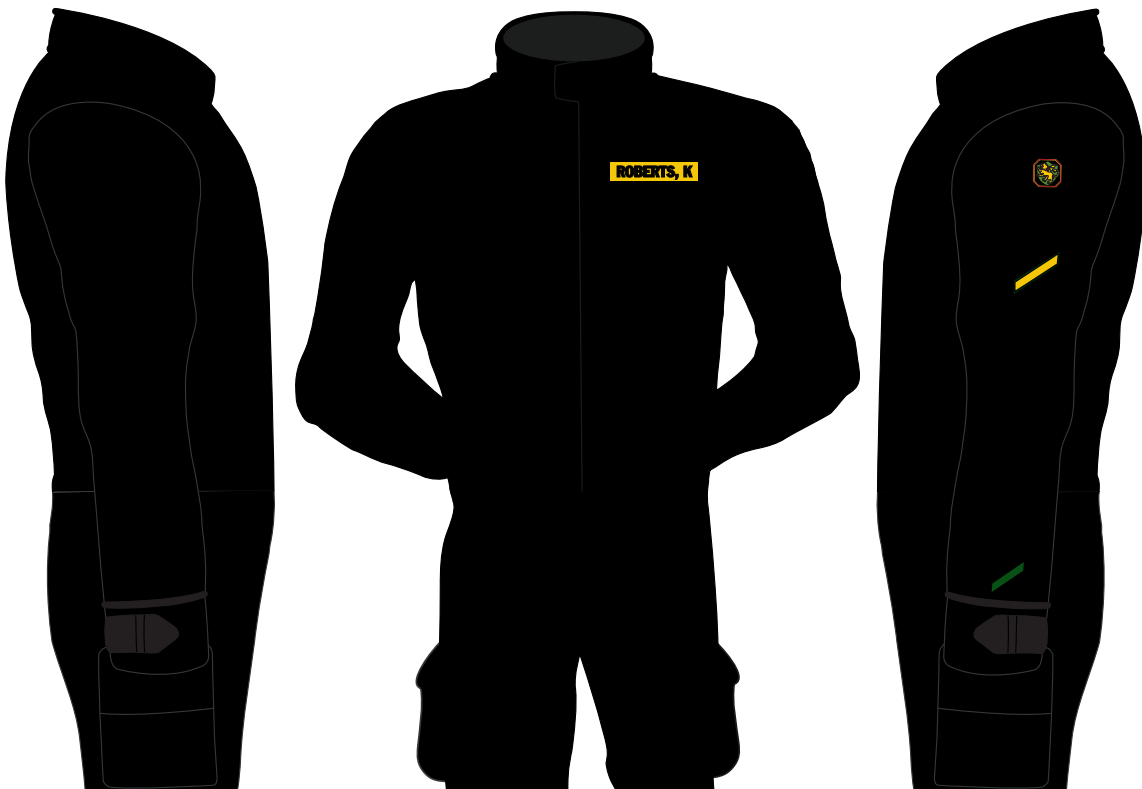

Working Uniform (continued)

Enlisted (E-4 through E-9):

Enlisted personnel in the grades of E-4 through E-9 wear a yellow fabric name tape with black embroidered lettering in the same manner as by those in the grades of E-1 through E-3.

Enlisted personnel do NOT display an additional embroidered rank tape below their name tape.

Enlisted personnel will display the appropriate number of gold chevrons/rockers for their current rank as well as their regimental insignia on the left sleeve only. Green service stripes, if earned, will be displayed on the lower left sleeve. Those personnel in the grades of E-7 through E-9 will trade their green service stripes for gold service stripes. For proper placement please consult the Measurement and Insignia Guide section of this manual.

A 1.5" forest green stripe is worn down the outer seam of each leg, beginning at the waist and ending at the cuff. Additionally, two forest green wedges are worn on the shoulders. The wedges should match the leg stripe.

The assignment patch and RMMC patch are not authorized for enlisted personnel wearing the working uniform, nor is any further ornamentation

Required Items:

- | | |
|---------------------------------------|---|
| 1. Black coveralls | 6. Gold rank chevrons/rockers |
| 2. Forest green 1.5" grosgrain ribbon | 7. Green/gold service stripe(s) as earned |
| 3. Black low-topped boots | 8. Forest green shoulder fabric |
| 4. Yellow embroidered name tape | 9. Forest green compression mock turtleneck |
| 5. Regimental patch | 10. Forest green beret with RMMC flash |



Undress Uniform

The undress uniform is worn by all personnel for most standard shipboard or ground side activities that do not involve dirty tasks or environments but would not warrant a more formal uniform variant. This uniform is considered the UOD (uniform of the Day) for all Royal Marines unless otherwise specified.

All ranks wear the RMMC patch affixed to the upper right sleeve.

All ranks wear their assignment patch and their regimental patch affixed to the upper left sleeve.

All ranks wear a forest green, close fitting, mock turtleneck.

All ranks wear a forest green RMMC beret with the RMMC flash positioned over the left eye.

Officers and warrant officers wear a black uniform tunic with forest green, untrimmed, trousers. The trousers are worn bloused into black, low-topped, boots or worn un-bloused with shined black oxford uniform shoes or boots. A black uniform belt with a gold military friction buckle is worn. A black fabric name tape with gold embroidered lettering is worn, affixed with Velcro, to the left breast of the uniform tunic. All name tapes should feature the wearers last name, first initial. For an example of the name tape, as well as a guide to proper placement, please consult the Measurement and Insignia Guide section of this manual.

Enlisted personnel wear coveralls and insignia identical to those worn for the working uniform with the additional insignia listed above.

OPTIONAL: A plain black, tactical style, belt may be worn, with the RMMC pulser and its accompanying drop leg holster, with the undress uniform. For officers and warrant officers, the belt should be worn under the tunic at the waist of the trousers. Enlisted personnel should wear the belt over their coveralls, at the natural waist.

The Space Warfare Pin, ribbon rack, or any other article not specifically indicated, are not authorized for wear with the undress uniform.

Undress Uniform (continued)

Officers:

The RMMC patch is worn on the upper right sleeve.

The assignment patch and regimental patch are worn on the upper left sleeve

Rank insignia is worn on the collar. no rank or RMMC brass is displayed on the uniform tunic epaulets.

Any award stripes earned are worn on the upper right sleeve, below the RMMC patch. For a guide to proper placement please consult the Measurement and insignia Guide section of this manual.

Required Items:

- | | |
|---|--|
| 1. Black uniform tunic | 7. Award stripe(s) as earned |
| 2. Forest green uniform trousers | 8. Assignment patch |
| 3. Black uniform belt with gold military buckle | 9. Regimental patch |
| 4. Black low-topped boots or shoes | 10. Gold/silver rank insignia |
| 5. Black embroidered name tape | 11. Forest green compression mock turtleneck |
| 6. RMMC patch | 12. Forest green beret with RMMC flash |



Undress Uniform (continued)

Warrant Officers:

The RMMC patch is worn on the upper right sleeve.

The assignment patch and regimental patch are worn on the upper left sleeve

Rank insignia is worn on the collar. No rank or RMMC brass is displayed on the uniform tunic epaulets. Warrant officers display silver rank chevrons appropriate to their rank on the left sleeve.

Any award stripes earned are worn on the upper right sleeve, below the RMMC patch. For a guide to proper placement please consult the Measurement and insignia Guide section of this manual.

Required Items:

- | | |
|---|--|
| 1. Black uniform tunic | 7. Award stripe(s) as earned |
| 2. Forest green uniform trousers | 8. Assignment patch |
| 3. Black uniform belt with gold military buckle | 9. Regimental patch |
| 4. Black low-topped boots or shoes | 10. Gold/silver rank insignia |
| 5. Black embroidered name tape | 11. Silver rank chevron(s) |
| 6. RMMC patch | 12. Forest green compression mock turtleneck |
| | 13. Forest green beret with RMMC flash |



Undress Uniform (continued)

Enlisted (E-1 through E-3):

The undress uniform for enlisted personnel in the grades of E-1 through E-3 is identical to the working uniform for those same grades with the following additions:

The RMMC patch is worn on the upper right sleeve.

The assignment patch is worn on the upper left sleeve

Any award stripes earned are worn on the upper right sleeve, below the RMMC patch. For a guide to proper placement please consult the Measurement and insignia Guide section of this manual.

Required Items:

- | | |
|---------------------------------|--|
| 1. Black coveralls | 7. Regimental patch |
| 2. Black low-topped boots | 8. Gold rank stripes |
| 3. Yellow embroidered name tape | 9. Green service stripe(s) as earned |
| 4. RMMC patch | 10. Forest green compression mock turtleneck |
| 5. Award stripe(s) as earned | 11. Forest green beret with RMMC flash |
| 6. Assignment patch | |

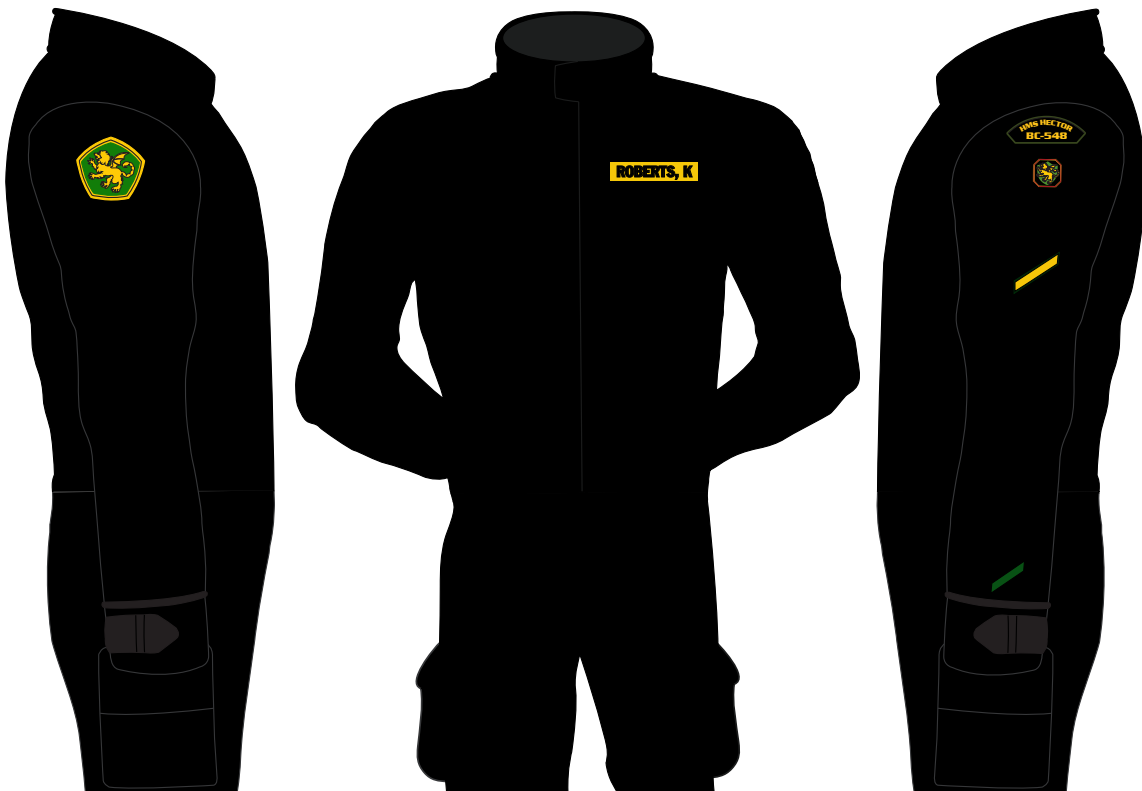

Undress Uniform (continued)

Enlisted (E-4 through E-9):

The undress uniform for enlisted personnel in the grades of E-4 through E-9 is identical to the working uniform for those same grades with the following additions:

The RMMC patch is worn on the upper right sleeve.

The assignment patch is worn on the upper left sleeve

Any award stripes earned are worn on the upper right sleeve, below the RMMC patch. For a guide to proper placement please consult the Measurement and insignia Guide section of this manual.

Required Items:

- | | |
|---------------------------------------|--|
| 1. Black coveralls | 8. Regimental patch |
| 2. Forest green 1.5" grosgrain ribbon | 9. Gold rank chevrons/rockers |
| 3. Black low-topped boots | 10. Green/gold service stripe(s) as earned |
| 4. Yellow embroidered name tape | 11. Forest green shoulder fabric |
| 5. RMMC patch | 12. Forest green compression mock turtleneck |
| 6. Award stripe(s) as earned | 13. Forest green beret with RMMC flash |
| 7. Assignment patch | |



Service Dress Uniform

The service dress uniform is the most formal uniform afforded most enlisted personnel and the standard uniform for all but the most formal of military activities. All personnel wear a uniform tunic for this uniform variant.

All ranks wear the RMMC patch affixed to the upper right sleeve.

All ranks wear their assignment patch and their regimental patch affixed to the upper left sleeve.

All ranks wear a forest green, close fitting, mock turtleneck.

All ranks wear a forest green RMMC beret with the RMMC flash positioned over the left eye.

All ranks may display awards that include a chest star, chest badge, or sash, if earned. Please consult TRMN-05, "Proper Wear and Display of the Knightly Orders and Chivalrous Awards," for further guidance.

All ranks wear forest green trousers bloused into black, low-topped, boots or worn un-bloused with shined black oxford uniform shoes or boots. A black uniform belt with a gold military friction buckle is worn.

Enlisted personnel in the grades of E-4 through E-10 will wear a 1.5" black stripe down the outer seam of each leg, beginning at the waist and ending at the cuff.

All ranks wear a gold, metal, name badge with black lettering, affixed with clutch pins or magnets, on the right breast of the uniform tunic. All name badges should feature the wearers last name, first initial. For an example of the name badge, as well as a guide to proper placement of insignia, buttons, and awards, please consult the Measurement and Insignia Guide section of this manual.

All ranks display medals on the left breast along with the Space Warfare Pin, if earned. If medals are unavailable, ribbons may be substituted. Any unit awards earned are displayed below the name badge.

Officers and warrant officers wear a black uniform tunic.

Enlisted personnel wear a short, Eisenhower style, tunic.

OPTIONAL: A plain black, tactical style, belt may be worn, with the RMMC pulser and its accompanying drop leg holster, with the service dress uniform. For all personnel, the belt should be worn under the tunic at the waist of the trousers.

Service Dress Uniform (continued)

Officers:

The RMMC patch is worn on the upper right sleeve.

The assignment patch and regimental patch are worn on the upper left sleeve

Rank insignia is worn on the collar and centered on the uniform tunic epaulets. RMMC brass is displayed on the uniform tunic epaulets.

Any award stripes earned are worn on the upper right sleeve, below the RMMC patch. For a guide to proper placement please consult the Measurement and insignia Guide section of this manual.

Required Items:

- | | |
|---|--|
| 1. Black uniform tunic | 7. Award stripe(s) as earned |
| 2. Forest green uniform trousers | 8. Assignment patch |
| 3. Black uniform belt with gold military buckle | 9. Regimental patch |
| 4. Black low-topped boots or shoes | 10. Gold/silver rank insignia |
| 5. Gold metal name badge | 11. RMMC brass |
| 6. RMMC patch | 12. Forest green compression mock turtleneck |
| | 13. Forest green beret with RMMC flash |



Service Dress Uniform (continued)

Warrant Officers:

The RMMC patch is worn on the upper right sleeve.

The assignment patch and regimental patch are worn on the upper left sleeve

Rank insignia is worn on the collar and centered on the uniform tunic epaulets. RMMC brass is displayed on the uniform tunic epaulets. Warrant officers display silver rank chevrons appropriate to their rank on the left sleeve

Any award stripes earned are worn on the upper right sleeve, below the RMMC patch. For a guide to proper placement please consult the Measurement and insignia Guide section of this manual.

Required Items:

- | | |
|---|--|
| 1. Black uniform tunic | 8. Assignment patch |
| 2. Forest green uniform trousers | 9. Regimental patch |
| 3. Black uniform belt with gold military buckle | 10. Gold/silver rank insignia |
| 4. Black low-topped boots or shoes | 11. Silver rank chevron(s) |
| 5. Gold metal name badge | 12. RMMC brass |
| 6. RMMC patch | 13. Forest green compression mock turtleneck |
| 7. Award stripe(s) as earned | 14. Forest green beret with RMMC flash |



Service Dress Uniform (continued)

Enlisted (E-1 through E-3):

The RMMC patch is worn on the upper right sleeve.

The assignment patch and regimental patch are worn on the upper left sleeve

Enlisted personnel will display the appropriate number of gold rank stripes for their current rank on the left sleeve. Green service stripes, if earned, will be displayed on the lower left sleeve. For proper placement please consult the Measurement and Insignia Guide section of this manual.

Any award stripes earned are worn on the upper right sleeve, below the RMMC patch. For a guide to proper placement please consult the Measurement and insignia Guide section of this manual.

Required Items:

- | | |
|---|--|
| 1. Black Eisenhower-style tunic | 8. Assignment patch |
| 2. Forest green uniform trousers | 9. Regimental patch |
| 3. Black uniform belt with gold military buckle | 10. Gold rank stripes |
| 4. Black low-topped boots or shoes | 11. Green service stripe(s) as earned |
| 5. Gold metal name badge | 12. Forest green compression mock turtleneck |
| 6. RMMC patch | 13. Forest green beret with RMMC flash |
| 7. Award stripe(s) as earned | |



Service Dress Uniform (continued)

Enlisted (E-4 through E-9):

The RMMC patch is worn on the upper right sleeve.

The assignment patch and regimental patch are worn on the upper left sleeve

Enlisted personnel will display the appropriate number of gold chevrons/rockers for their current rank on the left sleeve. Green service stripes, if earned, will be displayed on the lower left sleeve. Those personnel in the grades of E-7 through E-9 will trade their green service stripes for gold service stripes. For proper placement please consult the Measurement and Insignia Guide section of this manual.

Any award stripes earned are worn on the upper right sleeve, below the RMMC patch. For a guide to proper placement please consult the Measurement and insignia Guide section of this manual.

Required Items:

- | | |
|---|--|
| 1. Black Eisenhower-style tunic | 8. Assignment patch |
| 2. Forest green uniform trousers | 9. Regimental patch |
| 3. Black uniform belt with gold military buckle | 10. Gold rank chevrons/rockers |
| 4. Black low-topped boots or shoes | 11. Green/gold service stripe(s) as earned |
| 5. Gold metal name badge | 12. Forest green compression mock turtleneck |
| 6. RMMC patch | 13. Forest green beret with RMMC flash |
| 7. Award stripe(s) as earned | |



Dress Uniform

The dress uniform is the most formal uniform many officers and warrant officers will wear during their time in the service, and the most formal uniform authorized for senior non-commissioned officers in the grades of E-7 through E-10. It is worn for formal duties, such as those involving interaction with the public. It is a more formal version of the service undress uniform. All personnel wear a uniform tunic for this uniform variant. The wearing of a sidearm or holster is not authorized with the dress uniform.

All ranks wear the RMMC patch affixed to the upper right sleeve.

All ranks wear their assignment patch and their regimental patch affixed to the upper left sleeve.

All ranks wear a forest green, close fitting, mock turtleneck.

All ranks wear a forest green RMMC beret with the RMMC flash positioned over the left eye.

All ranks may display awards that include a chest star, chest badge, or sash, if earned. Please consult TRMN-05, "Proper Wear and Display of the Knightly Orders and Chivalrous Awards," for further guidance.

All ranks wear forest green trousers, un-bloused, with shined black oxford uniform shoes or boots. A black uniform belt with a gold military friction buckle is worn. Personnel should not blouse the trouser legs with the dress uniform.

All ranks wear a gold, metal, name badge with black lettering, affixed with clutch pins or magnets, on the right breast of the uniform tunic. All name badges should feature the wearers last name, first initial. For an example of the name badge, as well as a guide to proper placement of insignia, buttons, and awards, please consult the Measurement and Insignia Guide section of this manual.

All ranks display medals on the left breast along with the Space Warfare Pin, if earned. If medals are unavailable, ribbons may be substituted. Any unit awards earned are displayed below the name badge.

Officers and warrant officers wear a uniform identical to that worn for the service undress with the following addition. A double row of 18 gold TRMN buttons are worn on the plastron, 9 buttons on each side. Additionally, all officers and warrant officers will wear a 7/8" black satin stripe down the outer seam of each leg, beginning at the waist and ending at the cuff.

Senior non-commissioned officers in the grades of E-7 through E-10 wear the same uniform tunic and trousers as officers and warrant officers, with the exception that they will wear a 1.5" black satin stripe down the outer seam of each leg, beginning at the waist and ending at the cuff.

Dress Uniform (continued)

Officers:

The RMMC patch is worn on the upper right sleeve.

The assignment patch and regimental patch are worn on the upper left sleeve

Rank insignia is worn on the collar and centered on the uniform tunic epaulets. RMMC brass is displayed on the uniform tunic epaulets.

Any award stripes earned are worn on the upper right sleeve, below the RMMC patch. For a guide to proper placement please consult the Measurement and insignia Guide section of this manual.

Required Items:

- | | |
|---|--|
| 1. Black uniform tunic with buttons | 8. Award stripe(s) as earned |
| 2. Forest green uniform trousers | 9. Assignment patch |
| 3. 7/8" black satin stripe | 10. Regimental patch |
| 4. Black uniform belt with gold military buckle | 11. Gold/silver rank insignia |
| 5. Black low-topped boots or shoes | 12. RMMC brass |
| 6. Gold metal name badge | 13. Forest green compression mock turtleneck |
| 7. RMMC patch | 14. Forest green beret with RMMC flash |



Dress Uniform (continued)

Warrant Officers:

The RMMC patch is worn on the upper right sleeve.

The assignment patch and regimental patch are worn on the upper left sleeve

Rank insignia is worn on the collar and centered on the uniform tunic epaulets. RMMC brass is displayed on the uniform tunic epaulets. Warrant officers display silver rank chevrons appropriate to their rank on the left sleeve

Any award stripes earned are worn on the upper right sleeve, below the RMMC patch. For a guide to proper placement please consult the Measurement and insignia Guide section of this manual.

Required Items:

1. Black uniform tunic with buttons
2. Forest green uniform trousers
3. 7/8" black satin stripe
4. Black uniform belt with gold military buckle
5. Black low-topped boots or shoes
6. Gold metal name badge
7. RMMC patch
8. Award stripe(s) as earned
9. Assignment patch
10. Regimental patch
11. Gold/silver rank insignia
12. Silver rank chevron(s)
13. RMMC brass
14. Forest green compression mock turtleneck
15. Forest green beret with RMMC flash



Dress Uniform (continued)

Enlisted (E-7 through E-9):

The RMMC patch is worn on the upper right sleeve.

The assignment patch and regimental patch are worn on the upper left sleeve

Enlisted personnel will display the appropriate number of gold chevrons/rockers for their current rank on the left sleeve. RMMC brass is displayed on the uniform tunic epaulets. Gold service stripes, if earned, will be displayed on the lower left sleeve. For proper placement please consult the Measurement and Insignia Guide section of this manual.

Any award stripes earned are worn on the upper right sleeve, below the RMMC patch. For a guide to proper placement please consult the Measurement and insignia Guide section of this manual.

Required Items:

1. Black uniform tunic with buttons
2. Forest green uniform trousers
3. 1.5" black satin stripe
4. Black uniform belt with gold military buckle
5. Black low-topped boots or shoes
6. Gold metal name badge
7. RMMC patch
8. Award stripe(s) as earned
9. Assignment patch
10. Regimental patch
11. Gold rank chevrons/rockers
12. RMMC brass
13. Gold service stripe(s) as earned
14. Forest green compression mock turtleneck
15. Forest green beret with RMMC flash



Mess Dress Uniform

The mess dress uniform is reserved exclusively for warrant officers, officers, and those who hold the position of Regimental Sergeant Major and Sergeant Major of the Royal Manticoran Marine Corps. It is worn for the most formal of duties and is the military equivalent of civilian formal wear or court attire. A sword is worn by both warrant officers and officers. The RMMC naval sword is modeled after the 1805 Pattern Royal Navy officer's sword. Due to the unique nature of the sword, personal substitutions are NOT authorized per Admiralty House and Bureau Nine. The wearing of a sidearm or holster is not authorized with the mess dress uniform. White cotton parade gloves may be worn with the mess dress uniform.

Regimental Sergeant Majors, as well as the Sergeant Major of the Marine Corps, are not authorized to wear a sword with the mess dress uniform.

All ranks wear the RMMC patch affixed to the upper right sleeve.

All ranks wear their assignment patch and their regimental patch affixed to the upper left sleeve.

All ranks wear a forest green, close fitting, mock turtleneck.

All ranks wear a forest green RMMC beret with the RMMC flash positioned over the left eye.

All ranks may display awards that include a chest star, chest badge, or sash, if earned. Please consult TRMN-05, "Proper Wear and Display of the Knightly Orders and Chivalrous Awards," for further guidance.

All ranks wear forest green trousers, un-bloused, with shined black oxford uniform shoes or boots. A black uniform belt with a gold military friction buckle is worn. Personnel should not blouse the trouser legs with the mess dress uniform.

All ranks will wear a double stacked stripe down the outer seam of each leg, beginning at the waist and ending at the cuff. The stripe will be as follows: on the bottom is a 1" metallic gold stripe, with a 3/8" black satin stripe placed, centered, on top.

All ranks wear a gold, metal, name badge with black lettering, affixed with clutch pins or magnets, on the right breast of the uniform tunic. All name badges should feature the wearers last name, first initial. For an example of the name badge, as well as a guide to proper placement of insignia, buttons, and awards, please consult the Measurement and Insignia Guide section of this manual.

All ranks display medals on the left breast along with the Space Warfare Pin, if earned. If medals are unavailable, ribbons may be substituted. Any unit awards earned are displayed below the name badge.

Mess Dress Uniform (continued)

All ranks will wear a black, patent leather, USMC Sam Browne belt, with a matching USMC officer's sword hanger worn over top of a yellow gold sash, tied on the left with the two tassels hanging to just above the wearers knees. The RMMC sword should hang on the left and the Sam Browne shoulder strap should pass under the right epaulet. Both the sash and sword belt are worn at the wearers natural waist. If the wearer has elected to utilize the "tuck" method for realizing the mess dress uniform, the sash and sword belt will hide the effect. A link to a YouTube video has been included to provide instructions for wearing the sash and may be found in the Measurements and Insignia Guide section of this manual.

Regimental Sergeant Majors may wear one of two uniform tunics for the mess dress uniform.

The first, and most popular, is the same uniform tunic worn for the dress uniform. The tunic and plastron are simply tucked into the trousers, creating the look of a half jacket. No additional cuff detail is included on the Regimental Sergeant Majors mess dress uniform.

The second is a specially constructed half jacket and plastron that extends to the wearers waist. This jacket may be effected by utilizing the recommended pattern for mess dress uniforms, McCalls 4745, and only constructing the upper half of their "View A" jacket. A plastron and epaulets should then be constructed using the patterns included with the official TRMN officers jacket as a guide

Please consult the Special Uniforms of the Royal Manticoran Marine Corps section of this manual for specific information on this uniform type.

Sergeant Major of the Royal Manticoran Marine Corps may wear one of two uniform tunics for the mess dress uniform.

The first, and most popular, is the same uniform tunic worn for the dress uniform. The tunic and plastron are simply tucked into the trousers, creating the look of a half jacket. No additional cuff detail is included on the Sergeant Major of the Royal Manticoran Marine Corps mess dress uniform.

The second is a specially constructed half jacket and plastron that extends to the wearers waist. This jacket may be effected by utilizing the recommended pattern for mess dress uniforms, McCalls 4745, and only constructing the upper half of their "View A" jacket. A plastron and epaulets should then be constructed using the patterns included with the official TRMN officers jacket as a guide

Please consult the Special Uniforms of the Royal Manticoran Marine Corps section of this manual for specific information on this uniform type.

Warrant officers may wear one of two uniform tunics for the mess dress uniform.

The first, and most popular, is the same uniform tunic worn for the dress uniform. The tunic and plastron are simply tucked into the trousers, creating the look of a half jacket. An additional cuff detail is added to each sleeve of the mess dress uniform. For a closer view and more detailed example of the cuff detail, and recommendations for attachment, please consult the Measurement and Insignia Guide section of this manual.

The second is a specially constructed half jacket and plastron that extends to the wearers waist. This jacket may be effected by utilizing the recommended pattern for mess dress uniforms, McCalls 4745, and only constructing the upper half of their "View A" jacket. A plastron and epaulets should then be constructed using the patterns included with the official TRMN officers jacket as a guide.

Mess Dress Uniform (continued)

Company and Field Grade officers (O-1 through O-6) may wear one of two uniform tunics for the mess dress uniform.

The first, and most popular, is the same uniform tunic worn for the dress uniform. The tunic and plastron are simply tucked into the trousers, creating the look of a half jacket. An additional cuff detail is added to each sleeve of the mess dress uniform. For a closer view and more detailed example of the cuff detail, and recommendations for attachment, please consult the Measurement and Insignia Guide section of this manual.

The second is a specially constructed half jacket and plastron that extends to the wearers waist. This jacket may be effected by utilizing the recommended pattern for mess dress uniforms, McCalls 4745, and only constructing the upper half of their "View A" jacket. A plastron and epaulets should then be constructed using the patterns included with the official TRMN officers jacket as a guide.

General officers (F-1 through F-6) wear a long black, Civil War style, frock coat for the mess dress uniform.

The frock coat is styled in the same manner as all other RMMC uniform tunics with the main difference being the additional length. As such, additional buttons will be required for the plastron. An additional cuff detail is added to each sleeve of the mess dress uniform. For a closer view and more detailed example of the cuff detail, and recommendations for attachment, please consult the Measurement and Insignia Guide section of this manual.

This frock coat may be effected by utilizing the recommended pattern for mess dress uniforms, McCalls 4745, and constructing their "View B" coat, modified to zip up the front. An extended plastron and epaulets should then be constructed using the patterns included with the official TRMN officers jacket as a guide. Furthermore, on the rear of the frock coat, place a single gold TRMN button on the waist line above the point of each "tail." The finished frock coat should fall to just above the wearers knees.

Mess Dress Uniform (continued)

Regimental Sergeant Major:

The Regimental Sergeant Major will display three gold chevrons and three gold rockers and a full color, embroidered, crown insert appropriate for their current rank of E-10 on the left sleeve. RMMC brass is displayed on the uniform tunic epaulets. Gold service stripes, if earned, will be displayed on the lower left sleeve. For proper placement please consult the Measurement and Insignia Guide section of this manual.

Any award stripes earned are worn on the upper right sleeve, below the RMMC patch. For a guide to proper placement please consult the Measurement and insignia Guide section of this manual.

Required Items:

1. Black uniform tunic with buttons
2. Forest green uniform trousers
3. 1" metallic gold stripe
4. 3/8" black satin stripe
5. Black uniform belt with gold military buckle
6. Yellow gold sash
7. Black USMC Sam Browne belt
8. Black low-topped boots or shoes
9. Gold metal name badge
10. RMMC patch
11. Award stripe(s) as earned
12. Assignment patch
13. Regimental patch
14. Gold rank chevrons/rockers with insert
15. RMMC brass
16. Forest green compression mock turtleneck
17. Forest green beret with RMMC flash

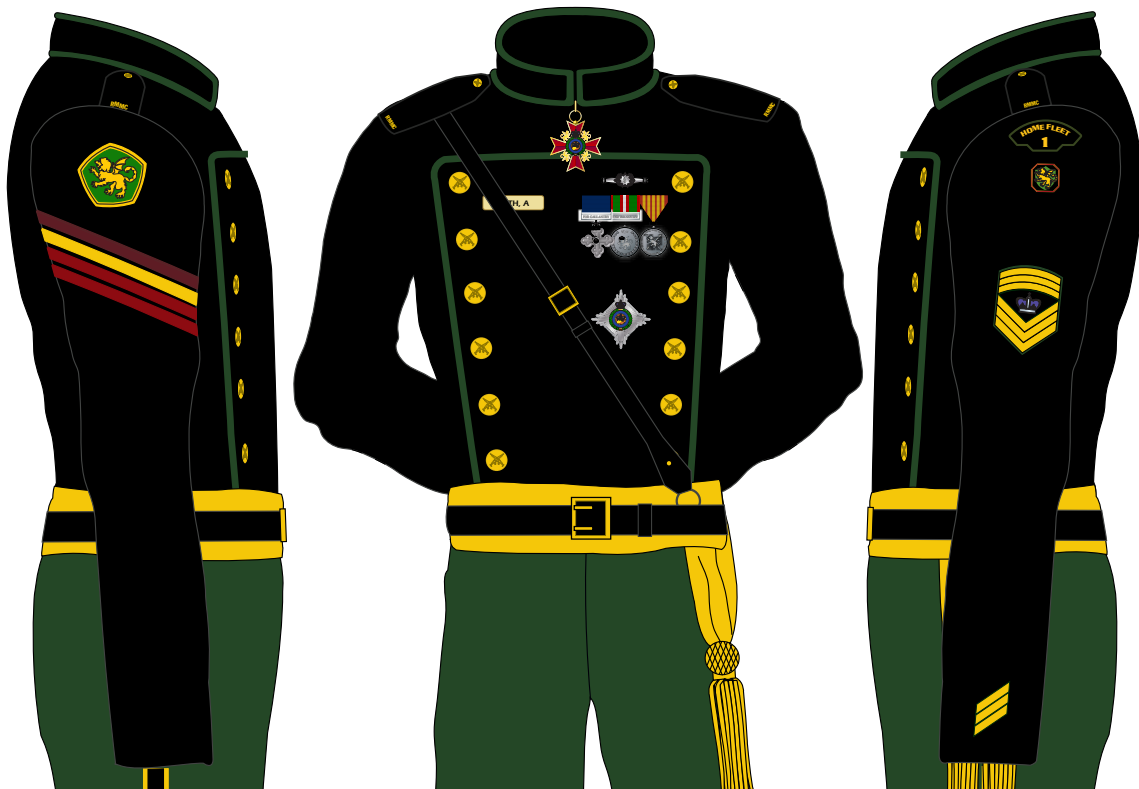

Mess Dress Uniform (continued)

Sergeant Major of the Royal Manticoran Marine Corps:

The Sergeant Major of the RMMC will display three gold chevrons and three gold rockers and a full color, embroidered, crown insert appropriate for their current rank of E-10 on the left sleeve. Additionally, a full color, embroidered, crown will be worn above the rank insignia. RMMC brass is displayed on the uniform tunic epaulets. Gold service stripes, if earned, will be displayed on the lower left sleeve. For proper placement please consult the Measurement and Insignia Guide section of this manual.

Any award stripes earned are worn on the upper right sleeve, below the RMMC patch. For a guide to proper placement please consult the Measurement and insignia Guide section of this manual.

Required Items:

- | | |
|---|--|
| 1. Black uniform tunic with buttons | 10. RMMC patch |
| 2. Forest green uniform trousers | 11. Award stripe(s) as earned |
| 3. 1" metallic gold stripe | 12. Assignment patch |
| 4. 3/8" black satin stripe | 13. Regimental patch |
| 5. Black uniform belt with gold military buckle | 14. Full color embroidered crown |
| 6. Yellow gold sash | 15. Gold rank chevrons/rockers with insert |
| 7. Black USMC Sam Browne belt | 16. RMMC brass |
| 8. Black low-topped boots or shoes | 17. Forest green compression mock turtleneck |
| 9. Gold metal name badge | 18. Forest green beret with RMMC flash |

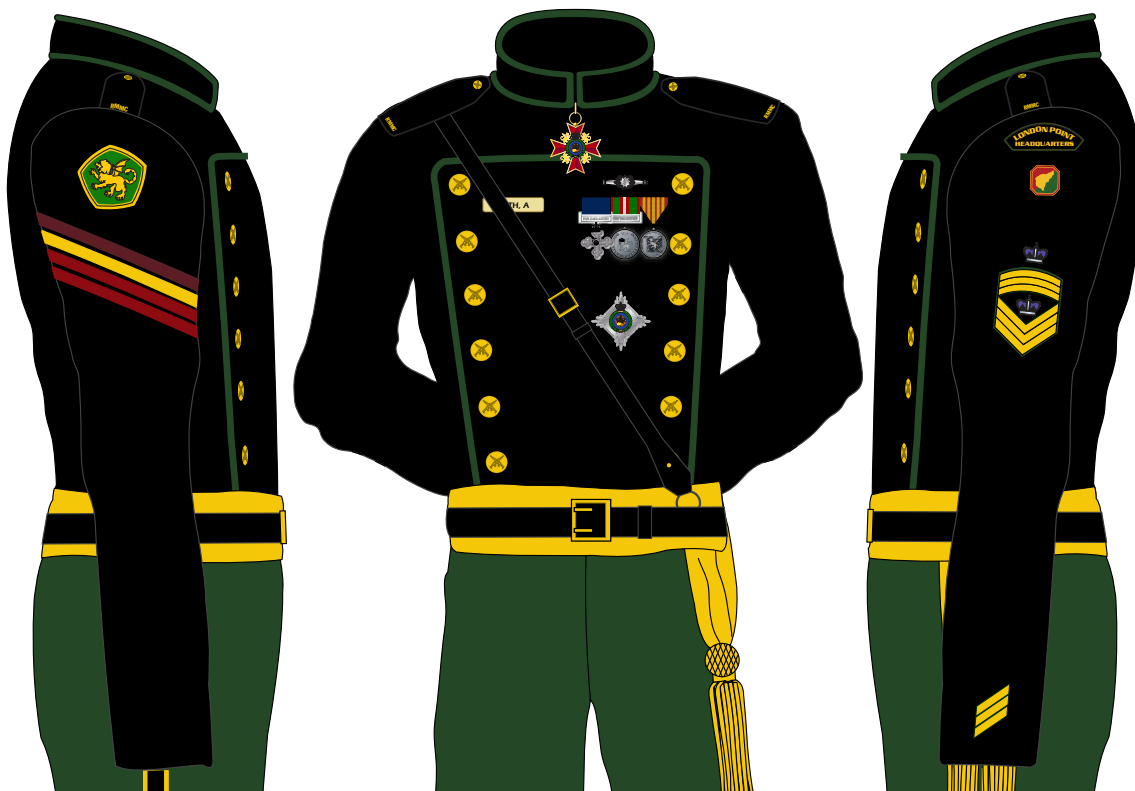

Mess Dress Uniform (continued)

Warrant Officers:

Rank insignia is worn on the collar and centered on the uniform tunic epaulets. RMMC brass is displayed on the uniform tunic epaulets. Warrant officers display silver rank chevrons appropriate to their rank on the left sleeve

Any award stripes earned are worn on the upper right sleeve, below the RMMC patch. For a guide to proper placement please consult the Measurement and insignia Guide section of this manual.

Required Items:

- | | |
|---|--|
| 1. Black uniform tunic with buttons | 11. Gold metal name badge |
| 2. Mess dress cuff detail (add-on or perm.) | 12. RMMC patch |
| 3. Forest green uniform trousers | 13. Award stripe(s) as earned |
| 4. 1" metallic gold stripe | 14. Assignment patch |
| 5. 3/8" black satin stripe | 15. Regimental patch |
| 6. Black uniform belt with gold military buckle | 16. Gold/silver rank insignia |
| 7. Yellow gold sash | 17. Silver rank chevron(s) |
| 8. Black USMC Sam Browne belt | 18. RMMC brass |
| 9. RMMC sword with hanging hardware | 19. Forest green compression mock turtleneck |
| 10. Black low-topped boots or shoes | 20. Forest green beret with RMMC flash |

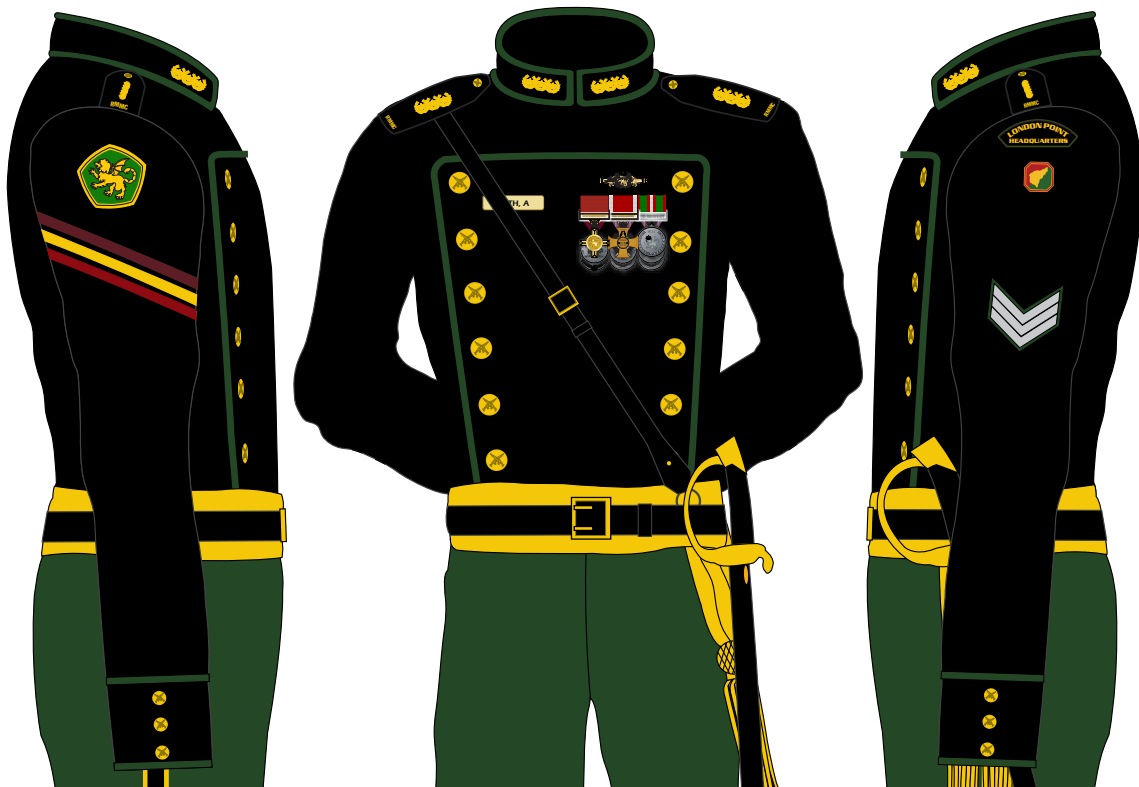

Mess Dress Uniform (continued)

Company and Field Grade Officers (O-1 through O-6):

Rank insignia is worn on the collar and centered on gold and green braided shoulder knots worn on the uniform tunic epaulets. RMMC brass is not displayed on the shoulder knots.

Any award stripes earned are worn on the upper right sleeve, below the RMMC patch. For a guide to proper placement please consult the Measurement and insignia Guide section of this manual.

Required Items:

1. Black uniform tunic with buttons
2. Mess dress cuff detail (add-on or perm.)
3. Forest green uniform trousers
4. 1" metallic gold stripe
5. 3/8" black satin stripe
6. Black uniform belt with gold military buckle
7. Yellow gold sash
8. Black USMC Sam Browne belt
9. RMMC sword with hanging hardware
10. Black low-topped boots or shoes
11. Gold metal name badge
12. RMMC patch
13. Award stripe(s) as earned
14. Assignment patch
15. Regimental patch
16. Gold/silver rank insignia
17. Gold/green shoulder knots
18. Forest green compression mock turtleneck
19. Forest green beret with RMMC flash

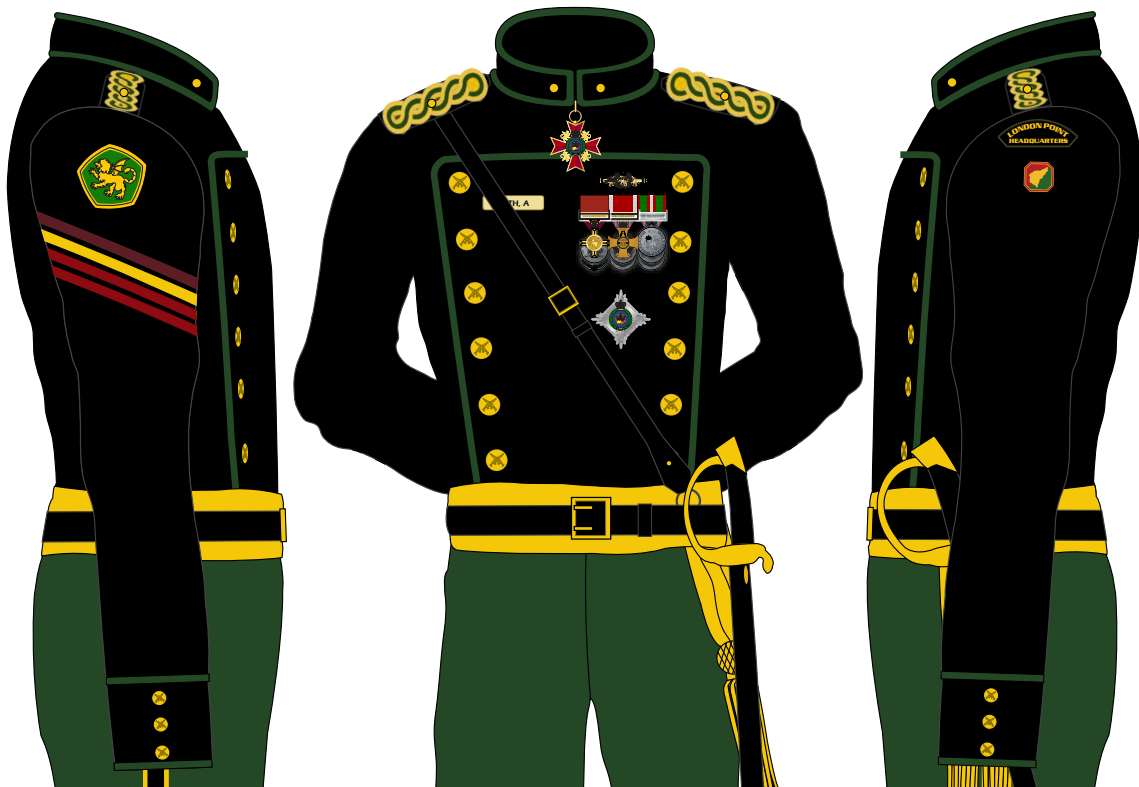

Mess Dress Uniform (continued)

General Officers (F-1 through F-6):

Rank insignia is worn on the collar and centered on gold and green braided shoulder knots worn on the uniform tunic epaulets. RMMC brass is not displayed on the shoulder knots.

Any award stripes earned are worn on the upper right sleeve, below the RMMC patch. For a guide to proper placement please consult the Measurement and insignia Guide section of this manual.

Required Items:

1. Black uniform frock coat with buttons
2. Mess dress cuff detail
3. Forest green uniform trousers
4. 1" metallic gold stripe
5. 3/8" black satin stripe
6. Black uniform belt with gold military buckle
7. Yellow gold sash
8. Black USMC Sam Browne belt
9. RMMC sword with hanging hardware
10. Black low-topped boots or shoes
11. Gold metal name badge
12. RMMC patch
13. Award stripe(s) as earned
14. Assignment patch
15. Regimental patch
16. Gold/silver rank insignia
17. Gold/green shoulder knots
18. Forest green compression mock turtleneck
19. Forest green beret with RMMC flash

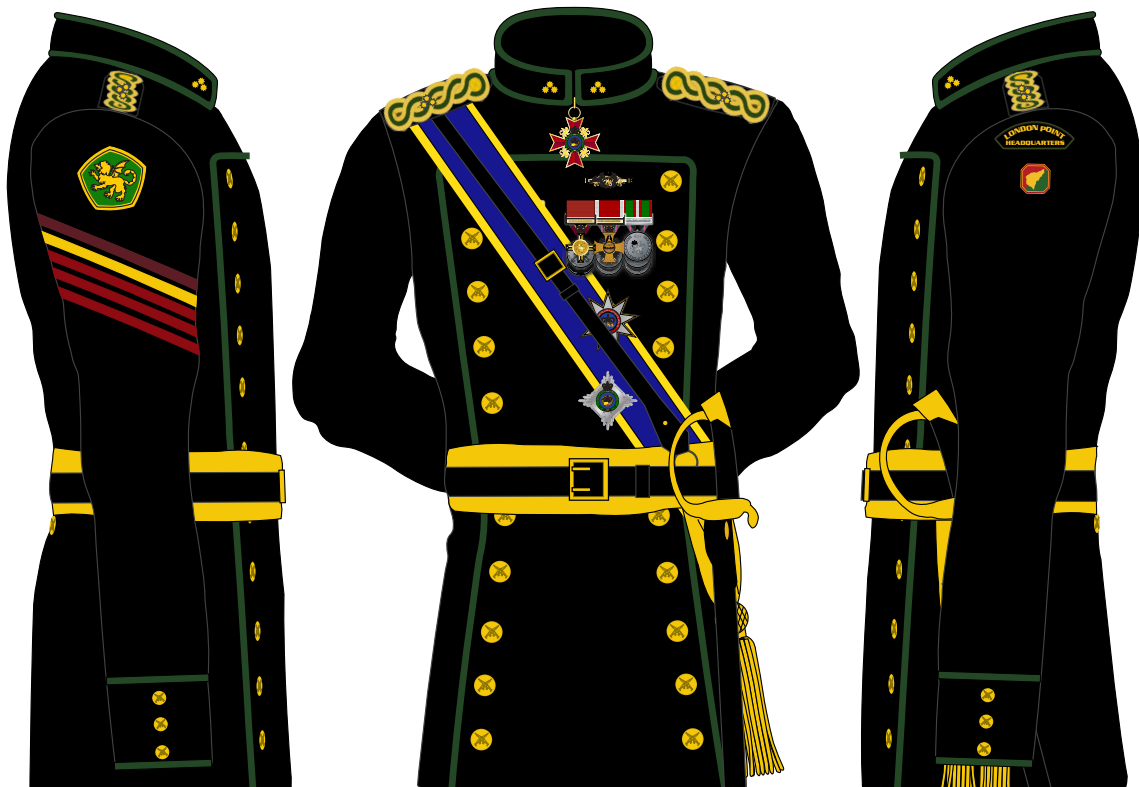

Special Uniforms of the Royal Manticoran Marine Corps

The following section contains written descriptions and illustrations that cover all available RMMC special uniforms. These uniforms are not common and are only worn by a select few personnel. These are position-specific uniforms, and once a wearer no longer holds one of the following positions they will revert to the standard RMMC uniform configuration appropriate to their rank.

There are currently only three special uniforms available, but as the Corps expands into different specialities there may be more special-case uniform varieties that become available. In such an eventuality, an updated edition of this uniform manual will be compiled and made available.

Covered in this section are:

Fleet Marine Force Gunnery Sergeants

Regimental Sergeant Majors

Sergeant Major of the Royal Manticoran Marine Corps

Each written description is designed to compliment the illustrations immediately following. Please reference the illustrations and the Measurement and Insignia Guide for proper placement of uniform items.

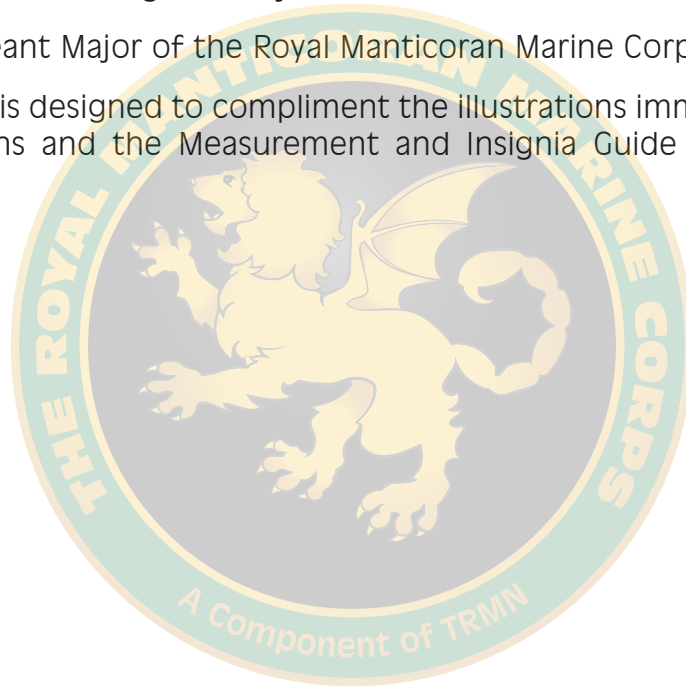

Important Note on Special Uniforms – Please Read before Continuing:

Special uniforms may ONLY be worn by personnel appointed to those positions by the appropriate authority. They generally represent some form of positional authority, or earned achievement, within the fan organization, and therefore are not uniforms that may just “be worn,” nor should they be utilized for cosplay purposes.

Thank you for your understanding.

Uniforms for Fleet Marine Force Corpsmen, being comprised solely of RMN personnel, may be found in RMN 1-03, Proper Wear and Appearance of Royal Navy Uniforms.

Special Uniforms – Fleet Marine Force Gunnery Sergeant

Fleet Marine Force Gunnery Sergeant (E-4 through E-9):

The FMF Gunnery Sergeant is the senior enlisted person in a shipboard Marine Detachment (MARDET.) As a member of the MARDET command team, and in smaller MARDETs, sometimes the entire command team, the FMF Gunnery Sergeant helps with the day-to-day running of the MARDET, acts as ombudsman to new personnel, and acts as an advocate and sounding board for the MARDET's enlisted personnel. Reporting directly to the MARDET commanding officer, or chapter executive officer in the absence of a Marine officer, the FMF Gunnery Sergeant keeps both the RMMC enlisted personnel and the RMMC officers accountable.

As an outward symbol of their positional authority, FMF Gunnery Sergeants will wear a black triangular rank insert upon which is embroidered crossed rifles in gold. For a guide to proper placement please consult the Measurement and insignia Guide section of this manual.

Only one FMF Gunnery Sergeant may exist per MARDET and the insert must be removed once the wearer no longer holds the position. The FMF Gunnery Sergeant will be appointed by the MARDET commanding officer, or in the absence of a Marine officer, by the chapter executive officer.

A FMF Gunnery Sergeant will hold the rank of E-4 or above, and thus is authorized all previously described uniform variants appropriate for their rank.

Required Items:

1. Items from Working Uniform
2. Items from Undress Uniform
3. Items from Service Dress Uniform
4. Items from Dress Uniform (E7-E10 only)
5. Crossed rifles rank insert

Special Uniforms – Fleet Marine Force Gunnery Sergeant (continued)

Fleet Marine Force Gunnery Sergeant (E-4 through E-9):



Special Uniforms – Fleet Marine Force Gunnery Sergeant (continued)

Fleet Marine Force Gunnery Sergeant (E-4 through E-9):



Special Uniforms – Regimental Sergeant Major

Regimental Sergeant Major (E-10 only):

The Regimental Sergeant Major is the senior enlisted Marine in a numbered regiment. Appointed by COMFORCECOM as a member of the command team, the Regimental Sergeant Major assists with the day to day running of the regiment, acts as ombudsman to new personnel, and acts as an advocate and sounding board for the MARDET Gunnery Sergeants and all enlisted personnel within the regiment. Reporting directly to Commander, Marine Forces Command, the Regimental Sergeant Major keeps both the RMMC enlisted personnel and the RMMC officers accountable.

As an outward symbol of their positional authority, Regimental Sergeant Majors will wear a black triangular rank insert upon which is embroidered a full color crown. For a guide to proper placement please consult the Measurement and insignia Guide section of this manual.

Regimental Sergeant Majors, regardless of MARDET assignment, will wear the assignment patch of their numbered fleet.

Only one Regimental Sergeant Major may exist per regiment and the insert must be removed once the wearer no longer holds the position.

The Regimental Sergeant Major will hold the restricted rank of E-10, and thus is authorized all previously described uniform variants appropriate for an E-9 Sergeant Major. Additionally, the Regimental Sergeant Major is authorized to wear the mess dress uniform.

Required Items:

1. Items from Working Uniform
2. Items from Undress Uniform
3. Items from Service Dress Uniform
4. Items from Dress Uniform
5. Items from Mess Dress Uniform
6. Embroidered crown rank insert

Special Uniforms – Regimental Sergeant Major (continued)

Regimental Sergeant Major (E-10 only):



Special Uniforms – Regimental Sergeant Major (continued)

Regimental Sergeant Major (E-10 only):



Special Uniforms – Sergeant Major of the RMMC

Sergeant Major of the Royal Manticoran Marine Corps (E-10 only):

The Sergeant Major of the Royal Manticoran Marine Corps is the senior enlisted Marine in the Royal Manticoran Marine Corps. Appointed by the Commandant of the Royal Manticoran Marine Corps as a member of the command team, the Sergeant Major of the RMMC assists with the day to day running of the Marine element, acts as ombudsman to new personnel, liaises with the Regimental Sergeant Majors, and acts as an advocate and sounding board for all enlisted personnel within the Marine element. Reporting directly to the Commandant of the Royal Manticoran Marine Corps, and Commander, Marine Forces Command, the Sergeant Major of the RMMC keeps the Marine element leadership accountable.

As an outward symbol of their positional authority, the Sergeant Major of the RMMC will wear a black triangular rank insert upon which is embroidered a full color crown. Additionally, a full color embroidered crown will be placed above the rank insignia. For a guide to proper placement please consult the Measurement and insignia Guide section of this manual.

The Sergeant Major of the Royal Manticoran Marine Corps is considered assigned to Headquarters, Royal Manticoran Marine Corps, and will wear the London Point Headquarters assignment patch as well as the Headquarters regimental patch.

The Sergeant Major of the Royal Manticoran Marine Corps will hold the restricted rank of E-10, and thus is authorized all previously described uniform variants appropriate for an E-9 Sergeant Major. Additionally, the Sergeant Major of the Royal Manticoran Marine Corps is authorized to wear the mess dress uniform.

Required Items:

1. Items from Working Uniform
2. Items from Undress Uniform
3. Items from Service Dress Uniform
4. Items from Dress Uniform
5. Items from Mess Dress Uniform
6. Embroidered crown rank insert
7. Full color embroidered crown

Special Uniforms – Sergeant Major of the RMMC (continued)
Sergeant Major of the Royal Manticoran Marine Corps (E-10 only):



Special Uniforms – Sergeant Major of the RMMC (continued)
Sergeant Major of the Royal Manticoran Marine Corps (E-10 only):



Measurement and Insignia Guide

The following section contains a measurement guide to assist with the proper placement of rank, insignia and awards. Also included are illustrations of the various ranks, pins, patches and special items available to RMMC personnel. Items only for the special uniforms are appropriately marked. These pages are designed to be individually printed for ease of use and reference.



Measurement and Insignia Guide

Warrant Officer/Officer Working Uniform:

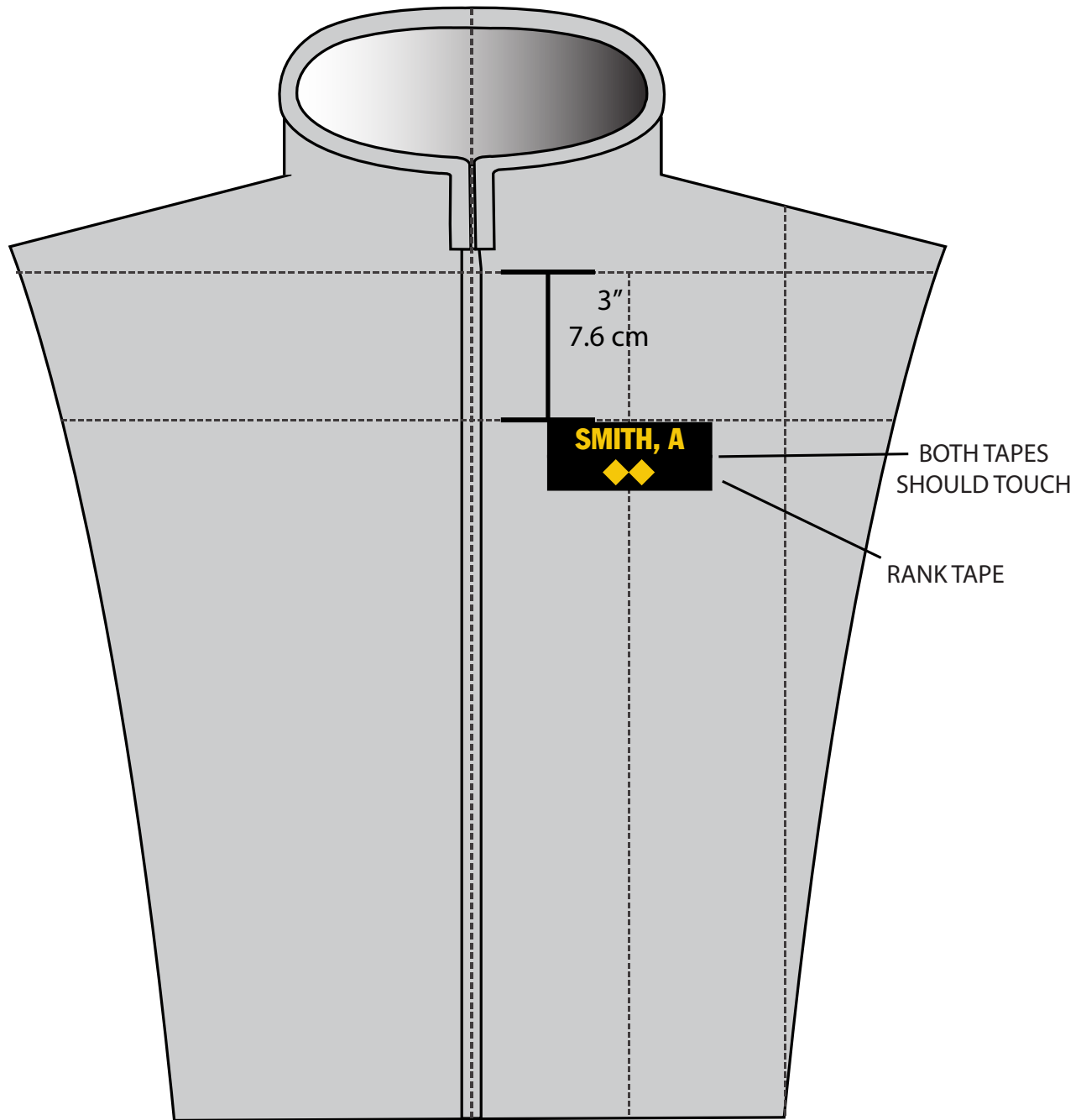

Measurement and Insignia Guide

Enlisted Working Uniform:

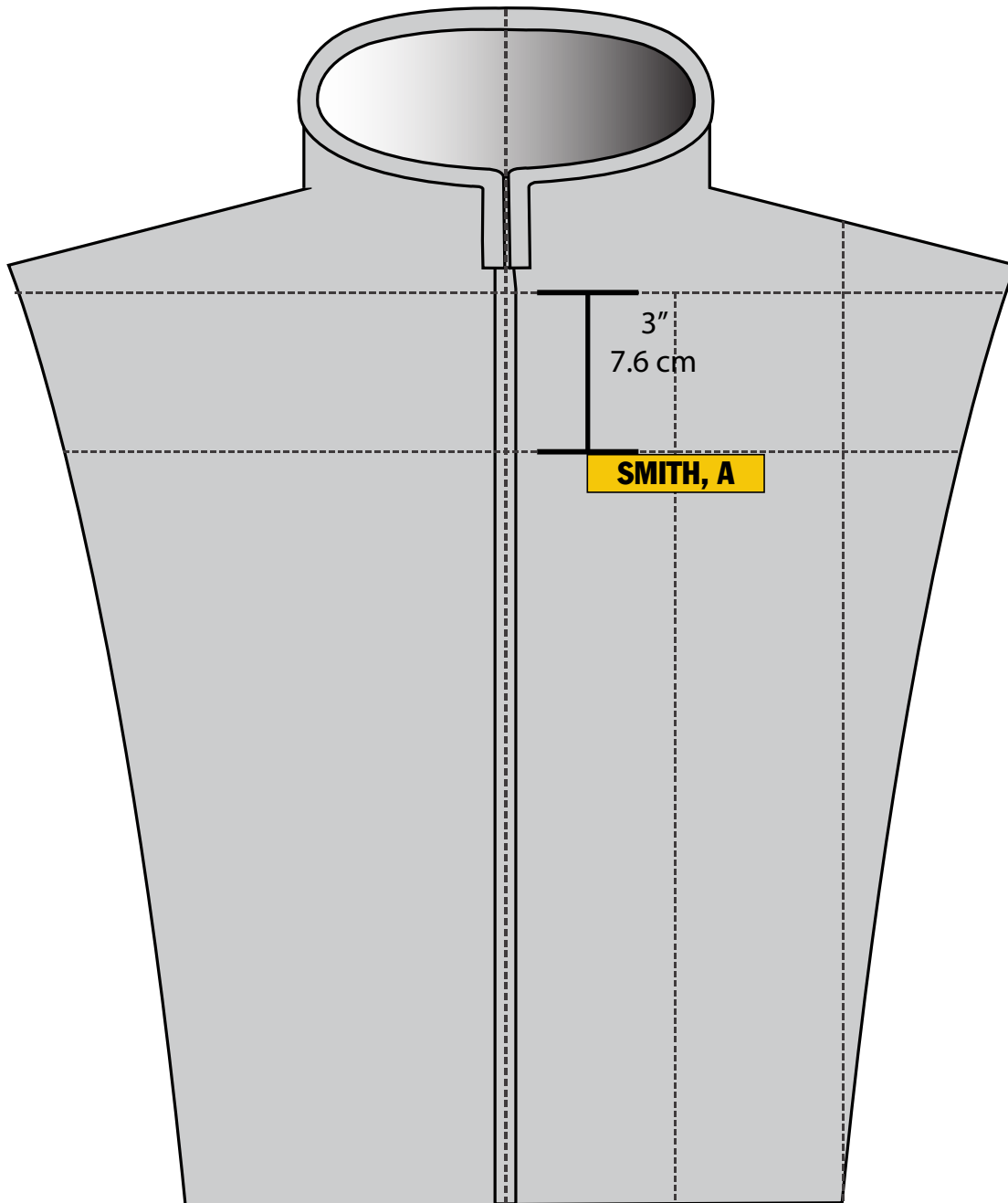

Measurement and Insignia Guide

Enlisted Service Dress Uniform:

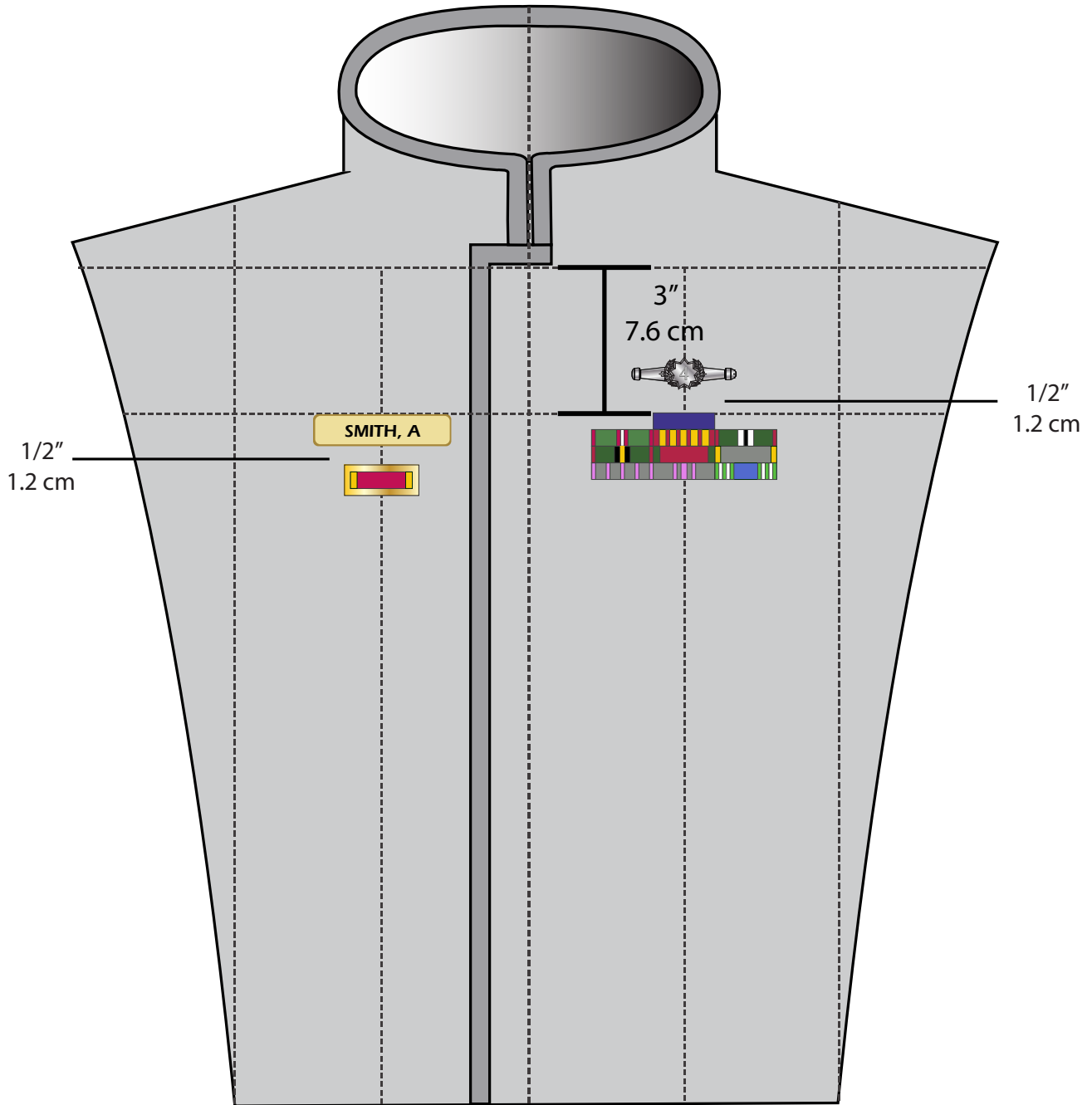

Measurement and Insignia Guide

Warrant Officer/Officer Undress Uniform:

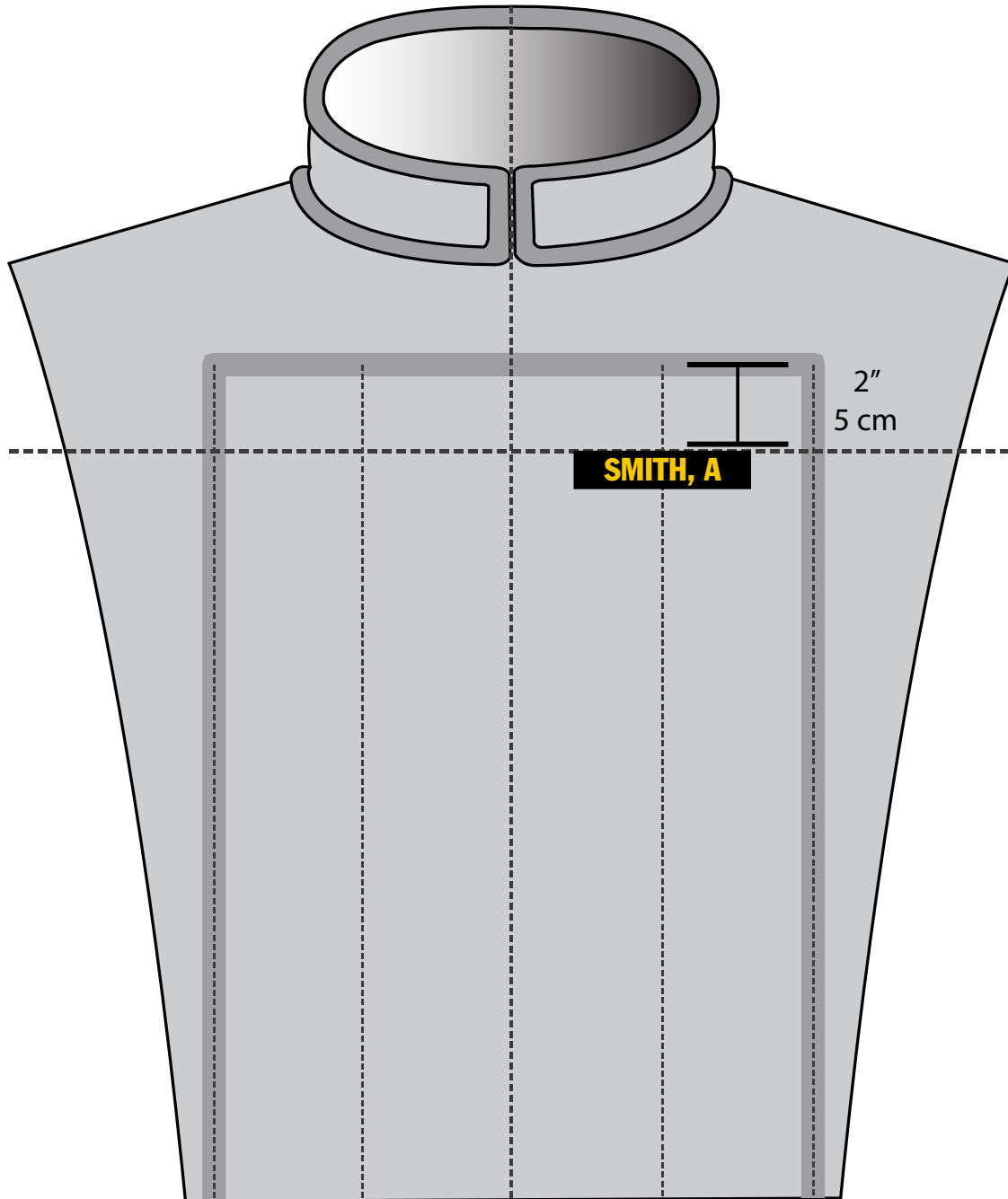

Measurement and Insignia Guide

Warrant Officer/Officer Service Dress Uniform:

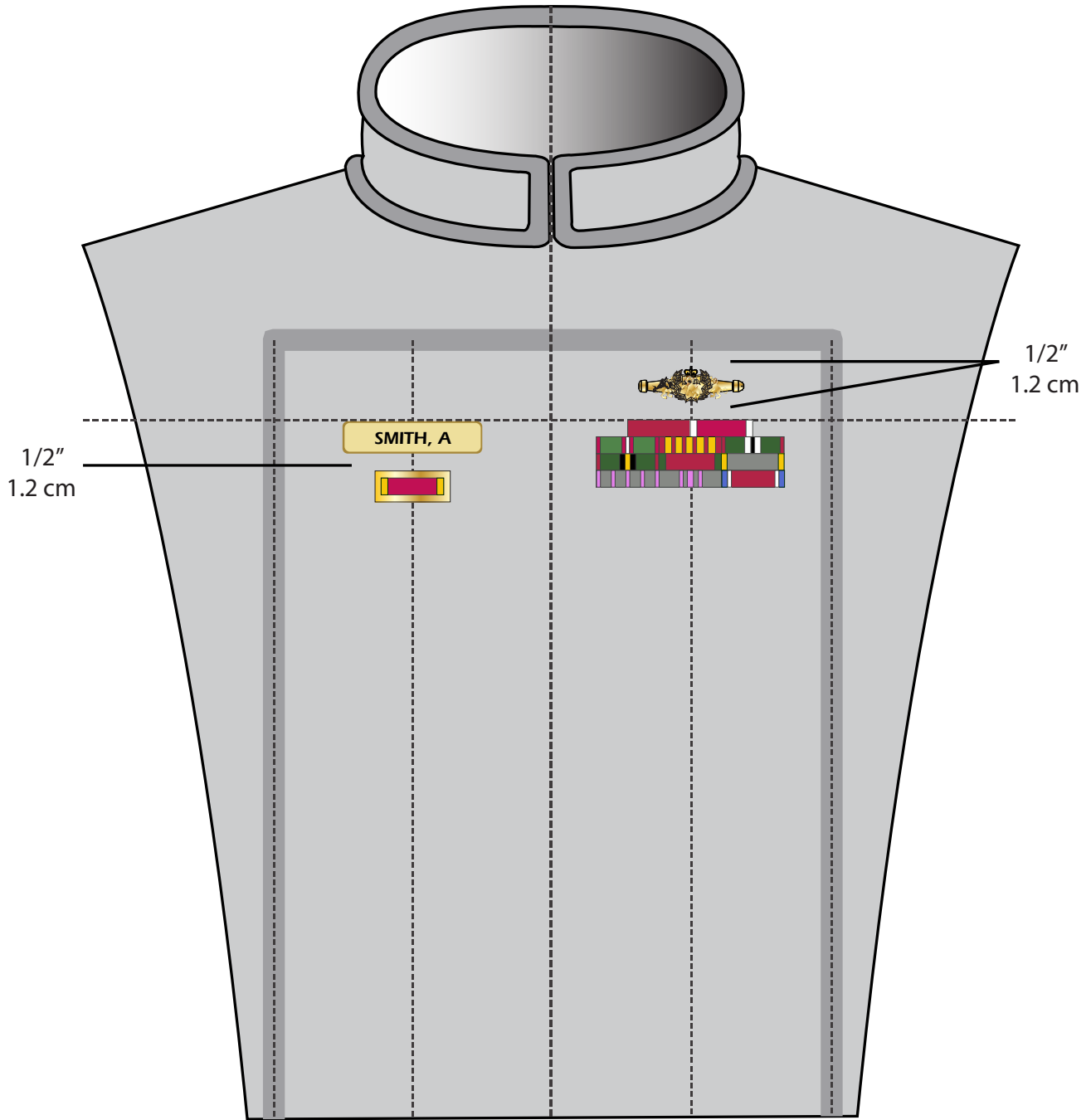

Measurement and Insignia Guide

E-7 through E-10/Warrant Officer/Officer Dress Uniform:

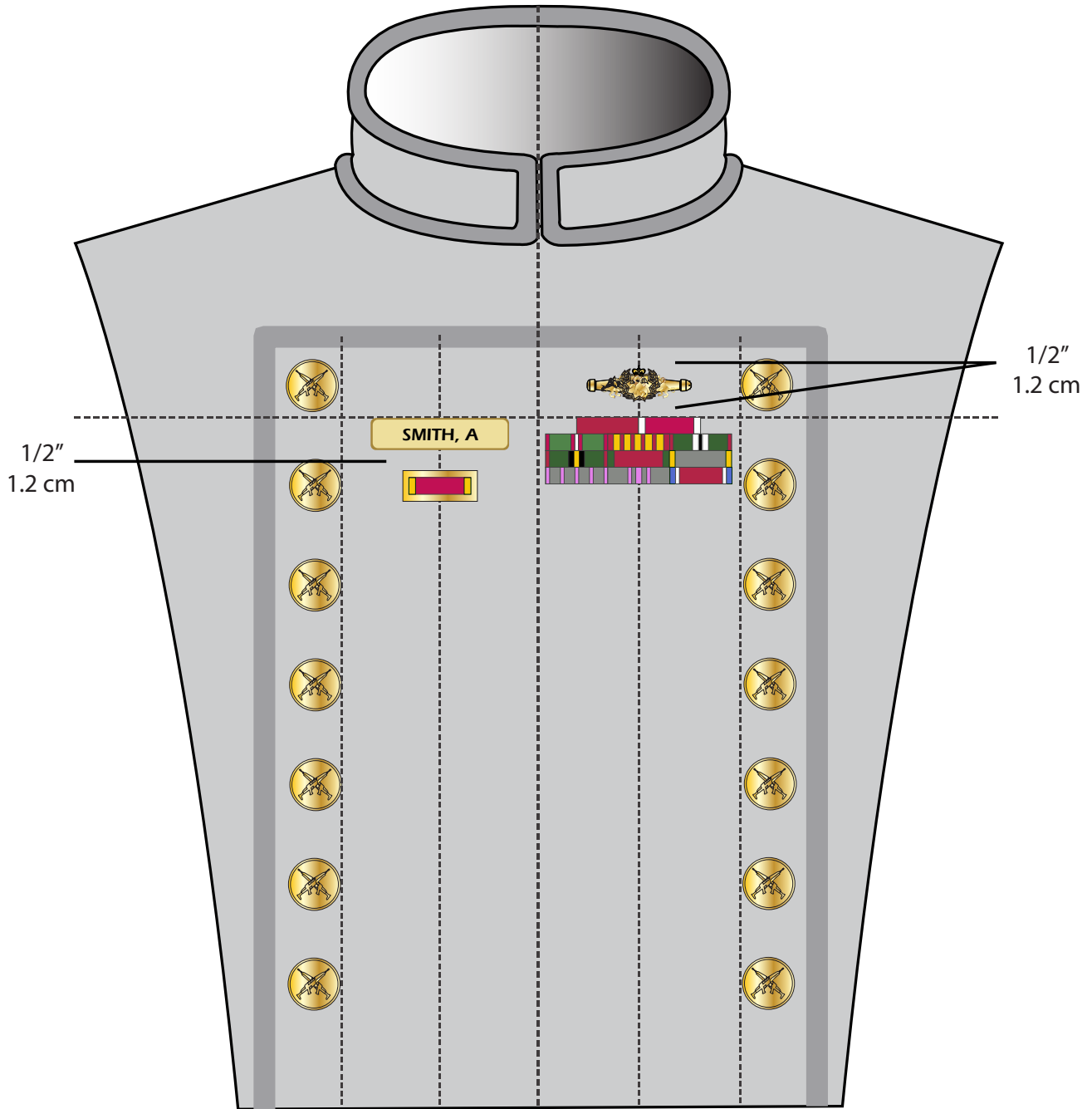

Measurement and Insignia Guide

Tunic Plastron (Bib) Buttons:

To place the tunic buttons first measure in from one side of the tunic 1/2" and make a mark with a fabric marking pencil or a piece of tailors chalk. Then measure down from the top of the tunic 1/2" and make a similar mark. Adjust so that both marks cross to form a "+." The center of the button will be sewn on that mark. To place the bottom button make a similar mark 1/2" in from the side, and make another mark, measuring up 5" from the bottom hem, so that both marks cross to form a "+." The remaining buttons should be evenly spaced between those two using a similar technique.

The plastron for service dress, dress, and warrant officer/company and field grade officer mess dress uniforms will take a total of 18 buttons, 9 on each side. The general officer frock coat will utilize more due to the additional length, but the top and bottom buttons should be placed per this guide.



Measurement and Insignia Guide

Collar Insignia Placement and Epaulet Setup:

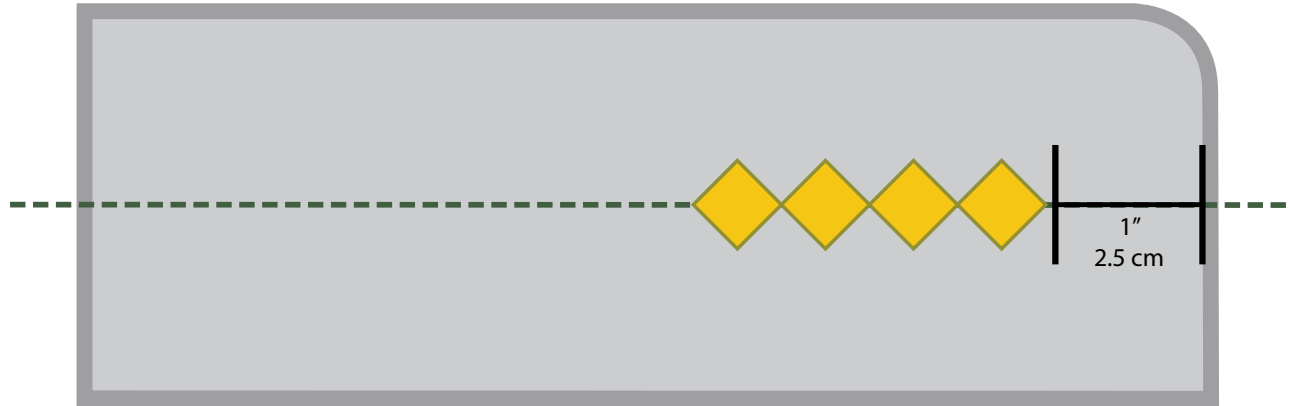

WARRANT OFFICER

OFFICER

OFFICER/WO
MESS DRESS ONLY

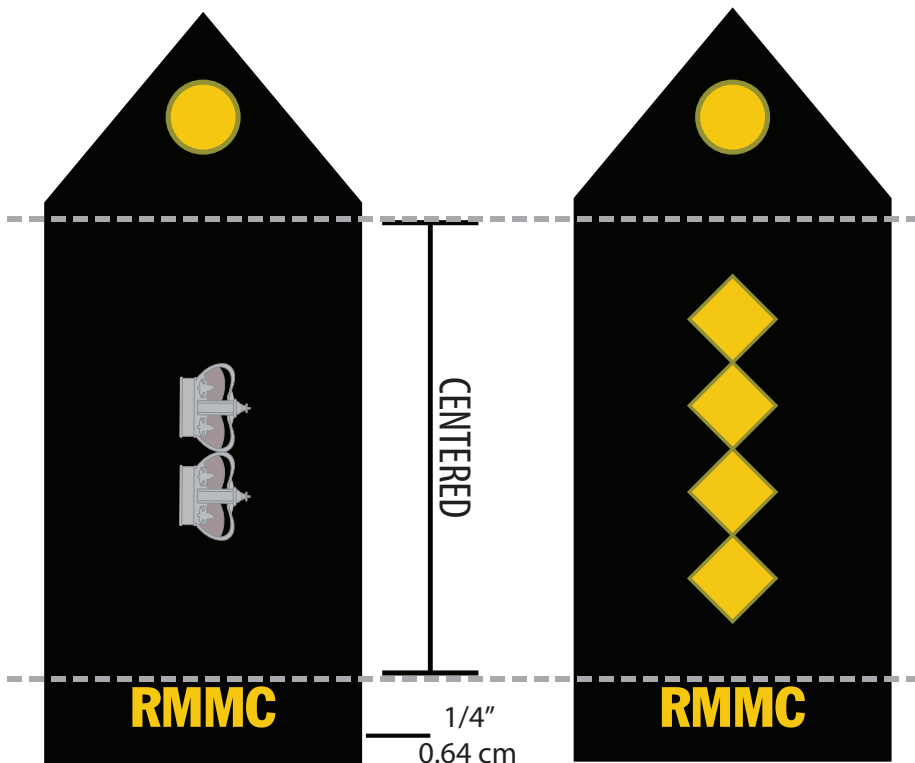

Measurement and Insignia Guide

RMMC Epaulet Insignia

The RMMC epaulet insignia shall be manufactured by the insignia company "Smith & Warren" and will be 1/2" tall. It shall consist of the letters "RMMC" in all caps with no period/dot between the letters. The insignia shall be gold. Please reference the included screen shot.

Further, it is important to point out that, with rare exception, custom insignia of this nature is sold individually NOT as a pair.



A link to the recommended company has been included in the Quartermaster's Corner section of this manual, however, the insignia may be purchased elsewhere as long as it is from the same manufacturer and of the same size.

Visual Badge Collar Insignia

Collars Brass Size

C501S (3/8")
 C501M (1/2")
 C501L (9/16")



 **ADD TO CART**
 **PRINT DESIGN**
 **EMAIL DESIGN**



Finish:

Quantity:

Attachment:

Characters:

Special Instructions:

ESTIMATED RETAIL PRICE* **\$30.00**

Item	Unit Price	Qty	Total
4 CHAR	\$15.00	2	\$30.00
0 ADDITIONAL CHAR	\$0.00	2	\$0.00
ATTACHMENT	\$0.00	2	\$0.00

*PRICED AND SOLD PER PIECE NOT PER PAIR

COLLAR BRASS PRICING*

NO. OF CHARS.	NICKEL	RHODIUM	GOLD
1	\$8.80	\$9.10	\$9.10
2	\$10.50	\$11.50	\$11.50
3	\$12.00	\$13.00	\$13.00
4	\$14.00	\$15.00	\$15.00
5	\$16.00	\$17.00	\$17.00
ADDITIONAL	\$3.00	\$3.00	\$3.00

*PRICED AND SOLD PER PIECE NOT PER PAIR

Uniform Board Suggestion: It is recommended that, whenever possible, members try to organize a group order for epaulet insignia to save on shipping costs.

Measurement and Insignia Guide

Warrant Officer and Enlisted Embroidered Rank Insignia:

To attach the warrant officer and enlisted rank insignia to a uniform, it is recommended that the insignia first be sewn to a piece of dark green felt. The felt should then be trimmed, leaving a small boarder as shown in the illustration, which can then be used to sew the insignia to the uniform jacket or tunic. 1/4" is recommended. Not only does this provide a sharp look, but it will make attaching the insignia much easier. Rank insignia is centered between the bottom of the regimental patch and the elbow.

Award Stripes:

Award stripes are placed according to the measurements shown in the illustration. Award stripes should be placed 3/8" apart from one another and in the following order: Monarchs Thanks, Mentioned in Dispatches, Wound Stripe(s). For the purposes of this illustration, all available award stripes are shown.

The stripe should tuck into the sleeve seam near the shoulder, and likewise should tuck into the sleeve seam on the inner arm. Like color thread should be used to sew the stripe in place.

For further information on these stripes please consult RMN 5-1, RMN/RMMC Awards Manual.

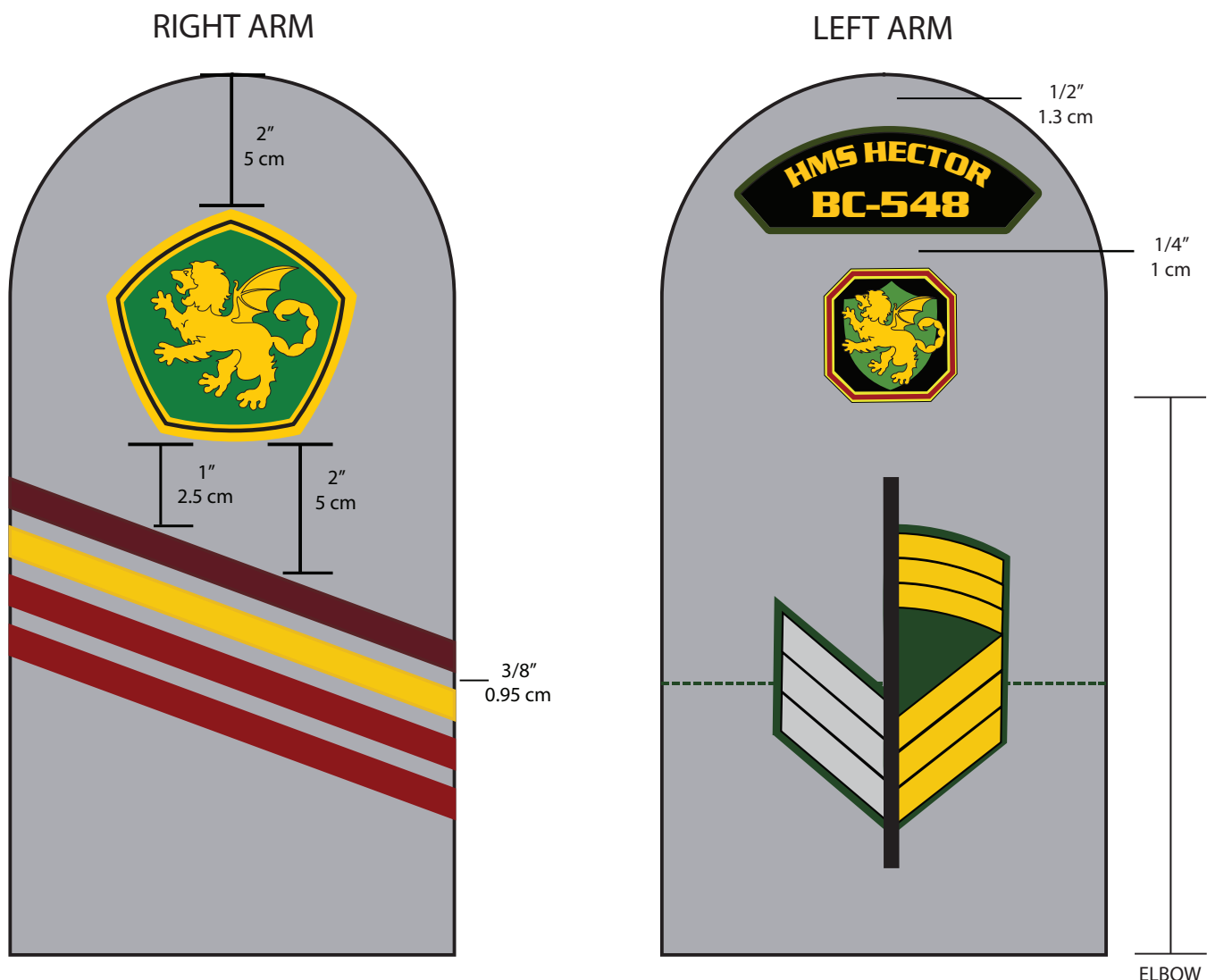

Measurement and Insignia Guide

Enlisted Service Stripes:

To attach the enlisted service stripes to a uniform, it is recommended that the stripes first be sewn to a piece of dark green felt. The felt should then be trimmed, leaving a small boarder as shown in the illustration, which can then be used to sew the stripes to the uniform jacket or tunic. 1/4" is recommended. Not only does this provide a sharp look, but it will make attaching the stripes much easier.

Officer and Warrant Officer Mess Dress Cuff Detail:

Warrant officers, and officers O-6 and below may wish to utilize a separately applied cuff detail that may be attached and removed as needed instead of making a separate mess dress tunic. Rare-Earth magnets are well suited for this task. When constructing that cuff, magnets should be sewn into the fabric at intervals. On the inside of the tunic sleeve two Velcro strips should be added, to which the opposite side of the Velcro, with the opposite rare-Earth magnets, may be placed. When the cuff is placed on the tunic sleeve it will stick in place. Three evenly placed, plain gold, pocket sized buttons, are centered on the outside of the cuff

Those members that construct a separate mess dress tunic are encouraged to permanently attach the separately constructed cuff as one would attach rank braid to the RMN uniforms.

BOTH ARMS
OFFICER/WARRANT OFFICER
MESS DRESS CUFF DETAIL

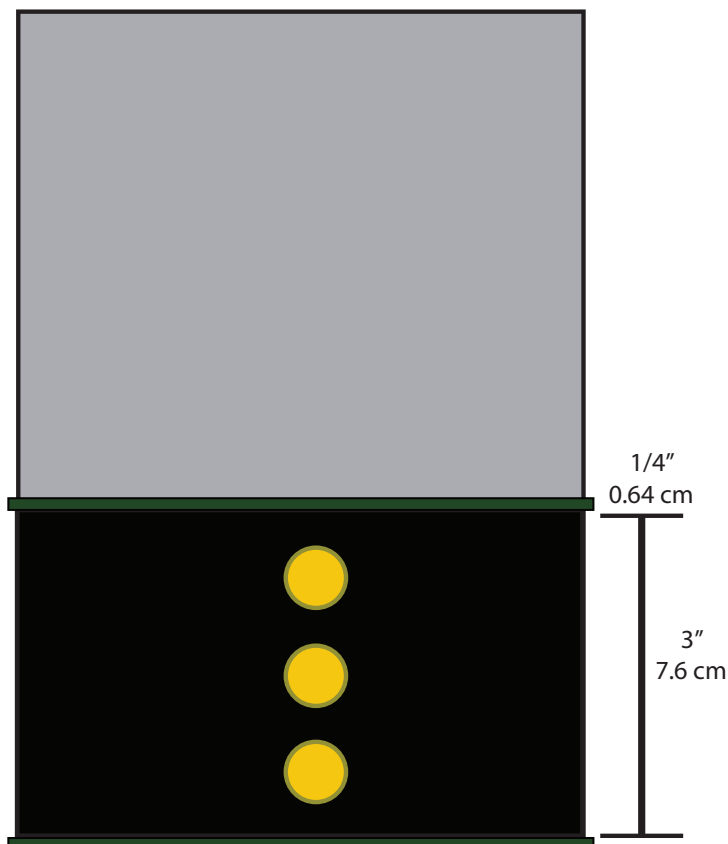

LEFT ARM
ALL ENLISTED

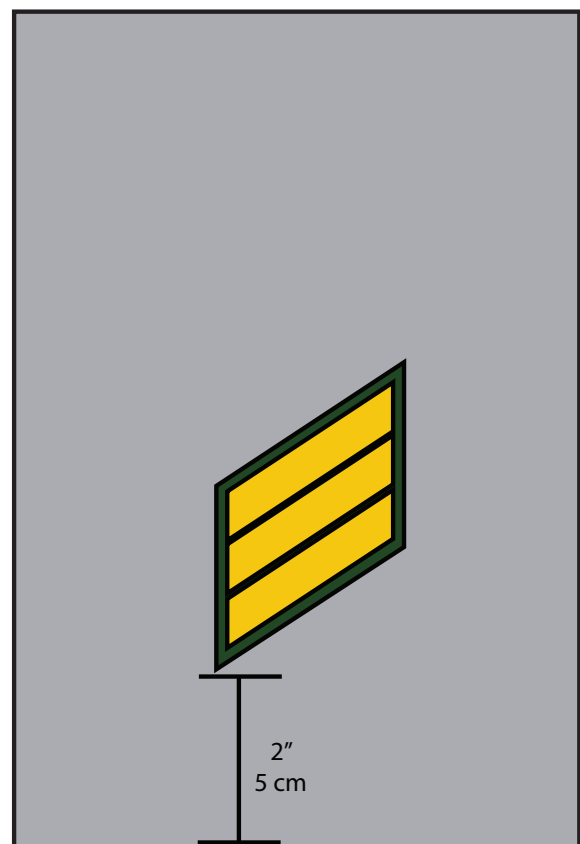

Measurement and Insignia Guide

MARDET PATCH EXAMPLES:



NUMBERED FLEET PATCH (AS WORN BY REGIMENTAL COMMAND STAFF):



HEADQUARTERS, RMMC (AS WORN BY ALL PERSONNEL ON THE MOTC'S STAFF):



TRAINING ACADEMY STAFF (AS WORN BY ALL RMMC BUTRAIN PERSONNEL):



Uniform Board Suggestion: Personnel who are members of multiple units may wish to cut a Velcro patch to form fit the assignment patch, fuzzy side on the uniform, to make swapping back and forth easier.

For example: If a member is part of MARDET Hector, but is also an instructor at Saganami Island, having the form fit Velcro behind the assignment patch will allow that member to represent both of their hats with ease.

Measurement and Insignia Guide

REGIMENTAL PATCH EXAMPLES:



Headquarters:

This regimental patch is worn by all unassigned RMMC personnel aboard HMSS Greenwich, all personnel assigned to London Point, as well as all personnel assigned to a BuTrain Academy (Saganami Island or Camp Maastricht.)



The Manticore Guard Regiment:

This regimental patch is worn by all RMMC personnel assigned to MARDETs in the First (Home) Fleet AOR. Additionally, this regimental patch is worn by all those personnel attached to the regimental command staff.

Currently Available Regimental Patches:

Headquarters Regiment (shown)

The Manticore Guards Regiment, First Fleet (shown)

The Montanero Regiment, Third Fleet

The Medusa Regiment, Eighth Fleet

The Lynx Regiment, Tenth Fleet

Uniform Board Suggestion: Personnel who are members of multiple units may wish to cut a Velcro patch to form fit the regimental patch, fuzzy side on the uniform, to make swapping back and forth easier.

For example: If a member is part of MARDET Hector, but is also an instructor at Saganami Island, having the form fit Velcro behind the regimental patch will allow that member to represent both of their hats with ease.

Measurement and Insignia Guide

RMMC BERET AND NAME BADGES:

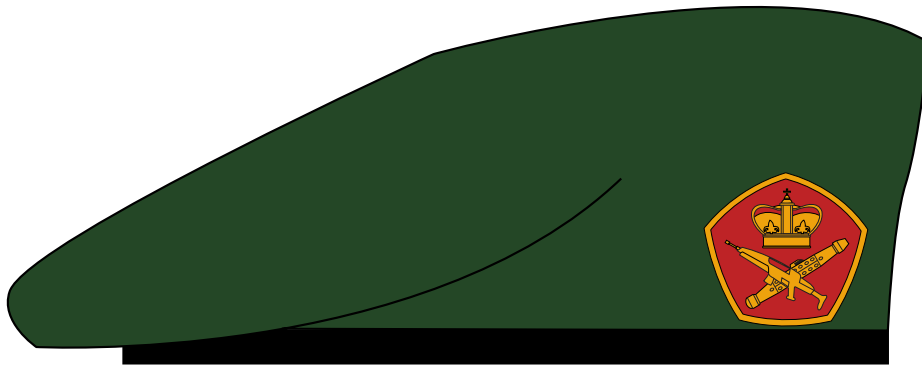

SMITH, A

ENLISTED
NAME TAPE

SMITH, A

WARRANT OFFICER/OFFICER
NAME TAPE

SMITH, A

ALL RANKS
NAME BADGE



OFFICER
RANK TAPE



WARRANT OFFICER
RANK TAPE

Uniform Board Suggestion: The TRMN Uniform Board recommends the GI Type Inspection Ready beret by Rothco. They arrive pre-formed and pre-shaved. All that is required is to sew on the RMMC beret flash. A link to the recommended supplier has been included in the Quartermaster's Corner section of this manual.

Measurement and Insignia Guide

RMMC Name Badge:

The RMMC metal name badge shall be purchased from "My Name Badges". It shall consist of the wearers last name, first initial. For example: "SMITH, A"

The name shall be in all caps with no period/dot after the first initial.

Those members who have earned a peerage may elect to wear a name badge with their peerage name. For example: The Grand Duke Montana may wear a name badge that says MONTANA.

A three magnet magnetic backing is generally accepted as the norm, however some members prefer to use a traditional clutch back.

A link to the company shown in the screenshot below is included in the Quartermaster's Corner section of this manual.

The screenshot displays the My Name Badges website interface. At the top, there is a navigation bar with links for Home, Plastic Name Badges, Metal Name Badges, Self-Expiring Badges, Make Your Own Badge, Visitor Badges, and Badge Buddy. The main content area features a product listing for a "0.625" x 2.5" MaestroBadge - Durable Metal, 5/8" x 2 1/2"". The product has a 4.7-star rating based on 6707 reviews. Below the product title, there is a "Design Your Own Badge" section. This section includes a text input field with the sample text "LAST, FI", a font selection dropdown set to "Optima", and a quantity selector set to "1". To the right of the text input, there are buttons for "B", "I", "U", and "A". Below the text input, there is a "Preview" button, an "Edit Design" button, and a "Spell Check" button. At the bottom of the design section, there is a "Total Saved Badges: 0 Badge" indicator. At the very bottom of the page, there are two buttons: "Save & Create More" and "Save & Next step".

Uniform Board Suggestion: This supplier offers price breaks for larger orders. It is recommended that, whenever possible, members try to organize a group order for name badges.

Measurement and Insignia Guide

COLD WEATHER FATIGUE FLIGHT PATCH EXAMPLES:



MENKEN, E
PRIVATE
INDEFATIGABLE



SMITH, A
RGT SGT MAJOR
TANN. RIFLES



ADAMS, C
LANCE CPL
IMPERATRIX



ANDREWS, J
WO1
SAGANAMI ISL



SMITH, A
PLATOON SGT
ACHILLES



ROBERTS, K
SMOTMC
LONDON POINT



GRISWOLD, R
SGT MAJOR
MAASTRICHT



NIEMEYER, S
MOTC
LONDON POINT

Measurement and Insignia Guide

COMPANY AND FIELD GRADE OFFICERS:

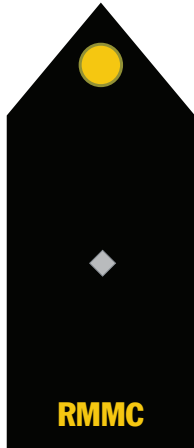

SECOND LIEUTENANT
O-1



FIRST LIEUTENANT
O-2



CAPTAIN
O-3



MAJOR
O-4



LIEUTENANT COLONEL
O-5

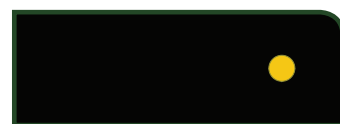

COLONEL
O-6

Measurement and Insignia Guide

GENERAL OFFICERS:

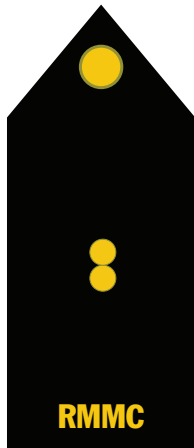

BRIGADIER GENERAL
F-1

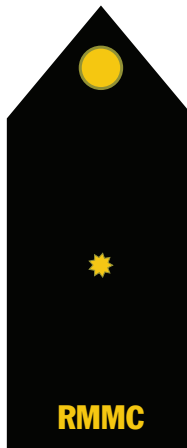

MAJOR GENERAL
F-2

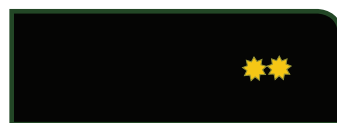
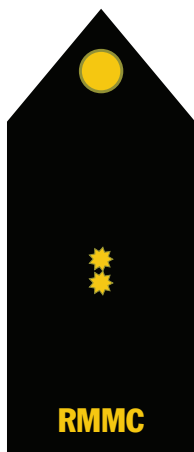

LIEUTENANT GENERAL
F-3

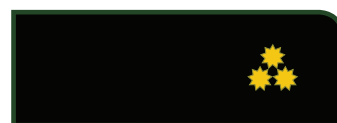

GENERAL
F-4

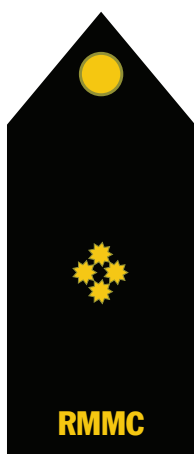

FIELD MARSHAL
F-5

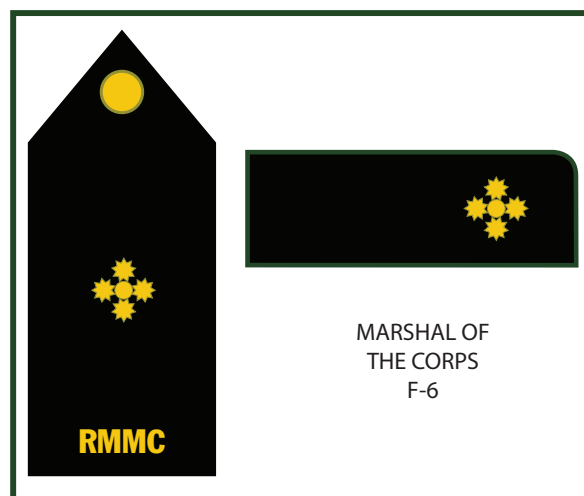

MARSHAL OF
THE CORPS
F-6

Only one Marshal of The Corps permitted on active duty at a time.

Measurement and Insignia Guide

WARRANT OFFICERS:

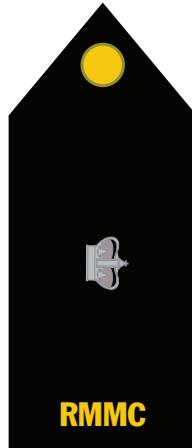

WARRANT OFFICER
W-1

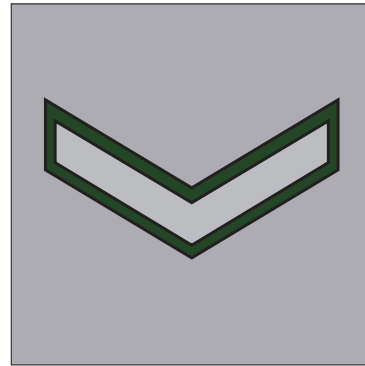

WARRANT OFFICER FIRST CLASS
W-2

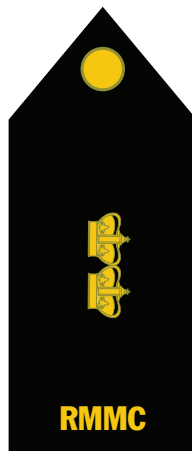
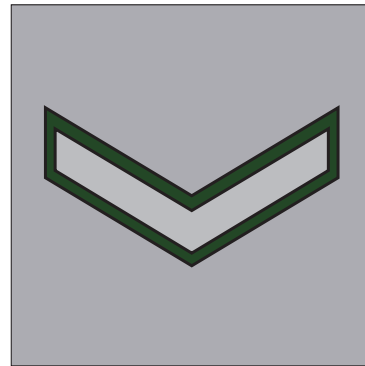

CHIEF WARRANT OFFICER
W-3

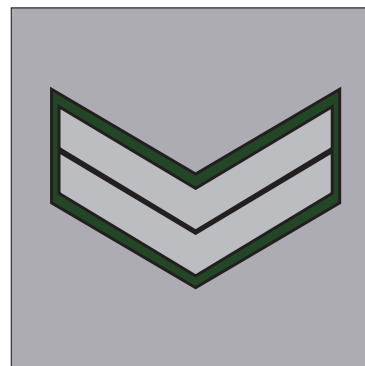

Measurement and Insignia Guide

WARRANT OFFICERS:



SENIOR CHIEF WARRANT OFFICER
W-4

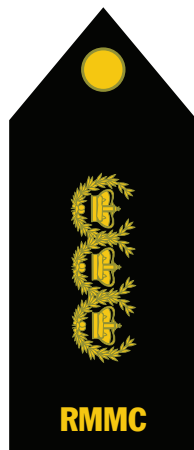
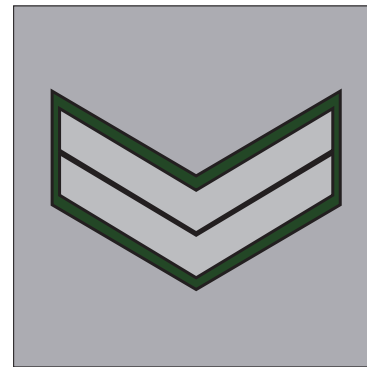

MASTER CHIEF WARRANT OFFICER
W-5



Uniform Board Suggestion: It is recommended that the insignia first be sewn to a piece of dark green felt. The felt should then be trimmed, leaving a small boarder as shown in the illustration, which can then be used to sew the insignia to the uniform jacket or tunic. 1/4" is recommended. Not only does this provide a sharp look, but it will make attaching the insignia much easier.

Measurement and Insignia Guide

ENLISTED RANKS:

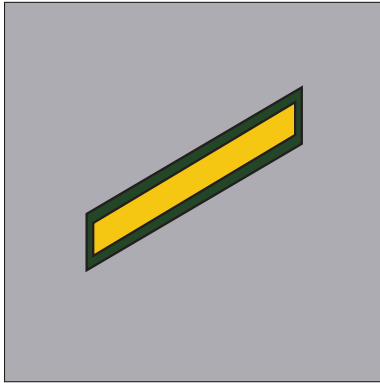

PRIVATE
E-1

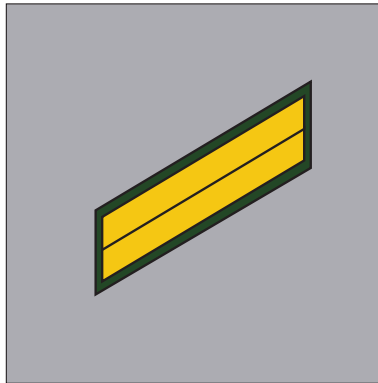

PRIVATE FIRST CLASS
E-2

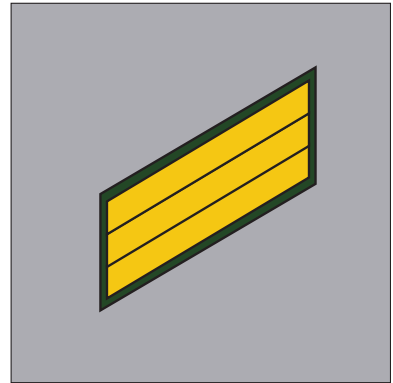

LANCE CORPORAL
E-3



CORPORAL
E-4



PLATOON SERGEANT
E-5



STAFF SERGEANT
E-6



MASTER SERGEANT
E-7



FIRST SERGEANT
E-8



SERGEANT MAJOR
E-9

Measurement and Insignia Guide

FLEET MARINE FORCE GUNNERY SERGEANT RANKS:



CORPORAL
FMF GUNNERY SERGEANT
E-4



PLATOON SERGEANT
FMF GUNNERY SERGEANT
E-5



STAFF SERGEANT
FMF GUNNERY SERGEANT
E-6



MASTER SERGEANT
FMF GUNNERY SERGEANT
E-7



FIRST SERGEANT
FMF GUNNERY SERGEANT
E-8



SERGEANT MAJOR
FMF GUNNERY SERGEANT
E-9

Measurement and Insignia Guide

SPECIAL ENLISTED RANKS:

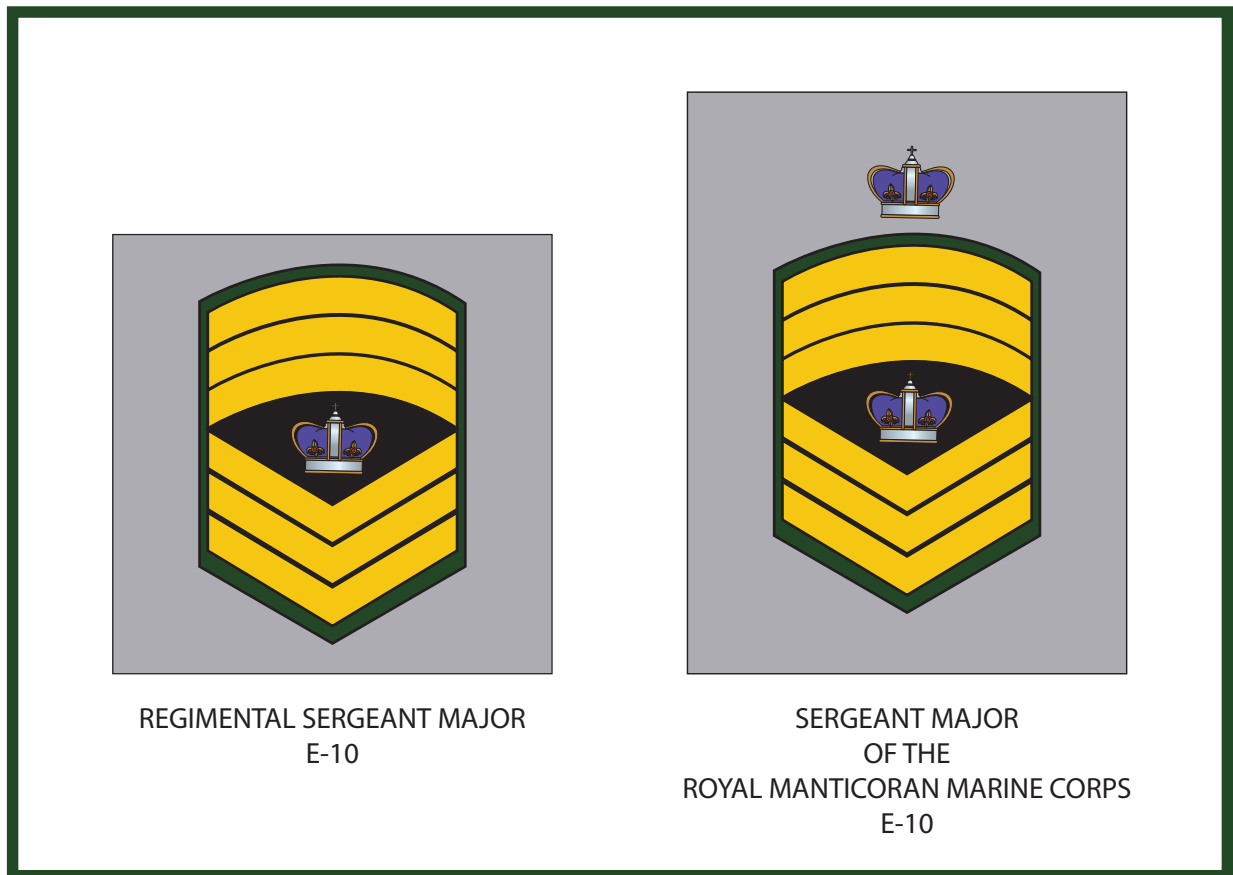

REGIMENTAL SERGEANT MAJOR
E-10

SERGEANT MAJOR
OF THE
ROYAL MANTICORAN MARINE CORPS
E-10

Uniform Board Suggestion: It is recommended that the insignia first be sewn to a piece of dark green felt. The felt should then be trimmed, leaving a small boarder as shown in the illustration, which can then be used to sew the insignia to the uniform jacket or tunic. 1/4" is recommended. Not only does this provide a sharp look, but it will make attaching the insignia much easier.

For the ranks of E-7 through E-9, the dark green felt backing should NOT be cut away from the center of the rank insignia.

For the E-10 special ranks, the crown insert will cover the dark green felt backing in the center.

Quartermaster's Corner

This section contains the names of merchants that will assist you in gathering the items necessary to construct your uniform. These suppliers have been vetted as satisfactory by the Uniform Board, and deliver a product consistent, both in look and quality, with our uniform regulations.

In most cases the cheapest possible supplier has been identified in an effort to make putting a uniform together as accessible to all as possible. Please contact a member of the Uniform Board if an alternative supplier is found that offers a cheaper price and we will gladly assess the item. If there are any questions, or any problems with the links, please contact a member of the Uniform Board or raise your concern on the Uniform Manuals section of the forum and we will be happy to assist you.

This section should be utilized in conjunction with the Required Items lists found on the Illustration pages.

To access the Quartermaster's Corner:

1. Log into the TRMN Forums
2. Navigate to the Bureau of Communications forum
3. Click on "Uniform Questions"
4. Click on "Uniform FAQs"
5. The topic should be pinned to the top of the board - click to open.





**THE ROYAL
MANTICORAN NAVY**

**The Official Honor Harrington
Fan Association**